

# Joint Optimal Power Control and Beamforming in Wireless Networks Using Antenna Arrays

Farrokh Rashid-Farrokhi, *Member, IEEE*, Leandros Tassiulas, *Member, IEEE*, and K. J. Ray Liu, *Senior Member, IEEE*

**Abstract**— The interference reduction capability of antenna arrays and the power control algorithms have been considered separately as means to increase the capacity in wireless communication networks. The minimum variance distortionless response beamformer maximizes the signal-to-interference-and-noise ratio (SINR) when it is employed in the receiver of a wireless link. In a system with omnidirectional antennas, power control algorithms are used to maximize SINR as well. In this paper, we consider a system with beamforming capabilities in the receiver, and power control. An iterative algorithm is proposed to jointly update the transmission powers and the beamformer weights so that it converges to the jointly optimal beamforming and transmission power vector. The algorithm is distributed and uses only local interference measurements. In an uplink transmission scenario, it is shown how base assignment can be incorporated in addition to beamforming and power control, such that a globally optimum solution is obtained. The network capacity and the saving in mobile power are evaluated through numerical study.

**Index Terms**— Adaptive beamforming, power control, space-division multiple access.

## I. INTRODUCTION

COCHANNEL interference is one of the main impairments that degrades the performance of a wireless link. Power control and antenna array beamforming are two approaches for improving the performance in wireless networks by appropriately controlling the cochannel interference.

In power control, the transmitter powers are constantly adjusted. They are increased if the signal-to-interference-and-noise ratio (SINR) is low and are decreased if the SINR is high. This improves the quality of weak links. Receivers employing antenna arrays adjust their beam patterns such that they have fixed gain toward the directions of their transmitters, while the aggregate interference power is minimized at their output.

Previous work, discussed later in more detail, addresses the problems of power control for optimal interference balancing and beamforming separately. In this paper, we consider the joint problem of power control and beamforming. We consider

Paper approved by R. A. Valenzuela, the Editor for Transmission Systems of the IEEE Communications Society. Manuscript received July 25, 1996; revised October 29, 1997 and March 30, 1998. This work was supported in part by National Science Foundation NYI Award MIP9457397 and a National Science Foundation CAREER Award. This paper was presented in part at GLOBECOM'96-1996 IEEE Global Telecommunications Conference, London, U.K., November 18–22, 1996.

F. Rashid-Farrokhi is with the Wireless Communications Research Department, Bell Laboratories, Lucent Technologies, Holmdel, NJ 07733 USA (e-mail: farrokhi@lucent.com).

L. Tassiulas and K. J. R. Liu are with the Electrical Engineering Department and Institute for Systems Research, University of Maryland, College Park, MD 20742 USA (e-mail: leandros@eng.umd.edu; kjrlu@eng.umd.edu).

Publisher Item Identifier S 0090-6778(98)07766-6.

a set of cochannel links, such as a set of cochannel uplinks in a cellular network, where only receivers employ antenna arrays. An algorithm is provided for computing the transmission powers and the beamforming weight vectors, such that a target SINR is achieved for each link (if it is achievable) with minimal transmission power. The algorithm is decentralized and amenable to a distributed implementation. It operates as follows. For a fixed power allocation, each base station maximizes the SINR using the minimum variance distortionless response (MVDR) beamformer. Next, the mobile powers are updated to reduce the cochannel interference. This operation is done iteratively until the vector of transmitter powers and the weight coefficients of the beamformers converge to the jointly optimal value. For the case that each transmitter can select its base station among a set of possible options, the algorithm easily extends to find the joint optimum power, base station, and beamforming.

The application of antenna arrays has been proposed in [1] to increase the network capacity in code-division multiple access (CDMA) systems. This paper assumed equal received power from all users in a cell. In [2]–[5], centralized power control schemes have been proposed to balance the carrier-to-interference ratio (CIR) or maximize the minimum CIR in all links. Those algorithms need global information about all link gains and powers. The distributed power control algorithm which uses only local measurements of SINR was presented in [6]–[9]. In [10] and [12], the combined base station assignment and power allocation were used to increase uplink capacity in wireless communication networks. In those papers, it was shown that if there exists at least one feasible base station assignment, the proposed algorithms will find the jointly optimal base station assignment and power allocation in the sense that the transmitted power is minimized for each mobile.

This paper is organized as follows. In Section II, we describe the system model and existing power control algorithms. Section III considers the beamforming problem in a network of users. In Section IV, we consider power allocation and beamforming as a joint problem and present an iterative algorithm for the joint problem which converges to the optimal solution, so that the allocated powers are minimum among all sets of feasible power allocations. In Section V, we integrate base station assignment with the power control and beamforming algorithm. In Section VI, a simulation study is done. We will show that our method increases the capacity in cases where users are uniformly dispersed around the network, and where some users are concentrated in a locally congested area in the network. The simulation results show that using

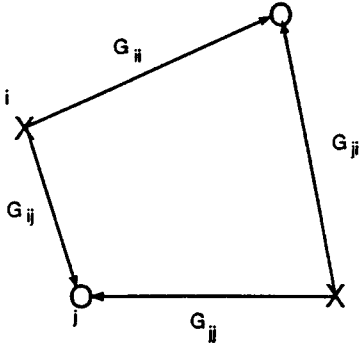

Fig. 1. A pair of cochannel links,  $i$  and  $j$ , is depicted.

antenna arrays at the base stations significantly increases the network capacity and/or the speed of convergence of the power control algorithm compared to the case where we use omnidirectional antennas.

## II. SYSTEM MODEL AND POWER CONTROL PROBLEM

A set of  $M$  transmitter–receiver pairs which share the same channel is considered. The shared channel could be a frequency band in frequency-division multiple access (FDMA), a time slot in time-division multiple access (TDMA), or even CDMA spreading codes. The link gain between transmitter  $i$  and receiver  $j$  is denoted by  $G_{ij}$ , and the  $i$ th transmitter power by  $P_i$ . For an isotropic antenna with unity gain in all directions, the signal power received at receiver  $i$  from transmitter  $j$  is  $G_{ji}P_j$ , as illustrated in Fig. 1. It is assumed that transmitter  $i$  communicates with receiver  $i$ . Hence, the desired signal at receiver  $i$  is equal to  $G_{ii}P_i$ , while the interfering signal power from other transmitters to receiver  $i$  is  $I_i = \sum_{j \neq i} G_{ji}P_j$ . If we neglect thermal noise, the CIR at the  $i$ th receiver is given by

$$\Gamma_i = \frac{G_{ii}P_i}{\sum_{j \neq i} G_{ji}P_j}.$$

The quality of the link from transmitter  $i$  to receiver  $j$  depends solely on  $\Gamma_i$ . The quality is acceptable if  $\Gamma_i$  is above a certain threshold  $\gamma_0$ , the *minimum protection ratio*. The minimum protection ratio is determined based on the signaling scheme and the link quality requirements (target bit error rate). Hence, for acceptable link quality,

$$\frac{G_{ii}P_i}{\sum_{j \neq i} G_{ji}P_j} \geq \gamma_0. \quad (1)$$

In matrix form, (1) can be written as follows:

$$\mathbf{P} \geq \gamma_0 \mathbf{F} \mathbf{P} \quad (2)$$

where  $\mathbf{P} = [P_1, P_2, \dots, P_M]^T$  is the power vector, and  $\mathbf{F}$  is a nonnegative matrix defined as

$$[\mathbf{F}]_{ij} = \begin{cases} 0 & \text{if } j = i \\ \frac{G_{ji}}{G_{ii}} > 0 & \text{if } j \neq i. \end{cases}$$

The objective of a power control scheme is to maintain the link quality by keeping the CIR above the threshold  $\gamma_0$ , that

is, to adjust the power vector  $\mathbf{P}$  such that (2) is satisfied. This problem has been studied extensively recently [2]–[12]. Given that  $\mathbf{F}$  is irreducible, it is known by Perron–Frobenius theorem that the maximum value of  $\gamma_0$  for which there exists a positive  $\mathbf{P}$  such that (2) is satisfied is  $1/\rho(\mathbf{F})$ , where  $\rho(\mathbf{F})$  is the spectral radius of  $\mathbf{F}$  [13]. According to this theorem, the power vector that satisfies (2) is the eigenvector corresponding to  $\rho(\mathbf{F})$  and is positive. Now, we will consider thermal noise at the receivers. The SINR at the  $i$ th receiver is then expressed as

$$\Gamma_i = \frac{G_{ii}P_i}{\sum_{j \neq i} G_{ji}P_j + N_i}$$

where  $N_i$  is the noise power at the  $i$ th receiver. The requirement for acceptable link quality is again

$$\Gamma_i \geq \gamma_0, \quad 1 \leq i \leq M$$

or, in matrix form,

$$[\mathbf{I} - \gamma_0 \mathbf{F}] \mathbf{P} \geq \mathbf{u} \quad (3)$$

where  $\mathbf{I}$  is an  $M \times M$  identity matrix, and  $\mathbf{u}$  is an element-wise positive vector with elements  $u_i$  defined as

$$u_i = \frac{\gamma_0 N_i}{G_{ii}}, \quad 1 \leq i \leq M.$$

The SINR threshold  $\gamma_0$  is achievable if there exists at least one solution vector  $\mathbf{P}$  that satisfies (3). The power control problem is defined as follows:

$$\begin{aligned} &\text{minimize} \quad \sum_i P_i \\ &\text{subject to} \quad [\mathbf{I} - \gamma_0 \mathbf{F}] \mathbf{P} \geq \mathbf{u}. \end{aligned}$$

It can be shown that, if the spectral radius of  $\mathbf{F}$  is less than  $1/\gamma_0$ , the matrix  $\mathbf{I} - \gamma_0 \mathbf{F}$  is invertible and positive [13]. In this case, the power vector

$$\hat{\mathbf{P}} = [\mathbf{I} - \gamma_0 \mathbf{F}]^{-1} \mathbf{u} \quad (4)$$

solves the optimization problem.

A centralized power control algorithm [4], [5] solves (4) by requiring all link gains in the network, and noise levels at receivers. In [6]–[8], a decentralized solution to the power control problem is proposed that solves (4) by performing the following iterations:

$$P_i^{n+1} = \frac{\gamma_0}{G_{ii}} \left( \sum_{j \neq i} G_{ji} P_j^n + N_i \right) = \frac{\gamma_0}{G_{ii}} I_i \quad (5)$$

where  $P_i^n$  is the  $i$ th mobile power at the  $n$ th iteration step. The right-hand side of (5) is a function of the interference at the  $i$ th receiver, denoted by  $I_i$ , as well as the link gain between each receiver and its transmitter ( $G_{ii}$ ). That is, there is no need to know all the existing path gains and transmitter powers in order to update the powers. At each iteration, transmitters update their powers based on the interference measured at the receivers and the link gain between each transmitter and its own receiver. The link gain can be measured from the information sent in the control channel. It has been shown in [6]–[8] that, starting from any arbitrary power vector, this iteration converges to the optimal solution  $\hat{\mathbf{P}}$ .

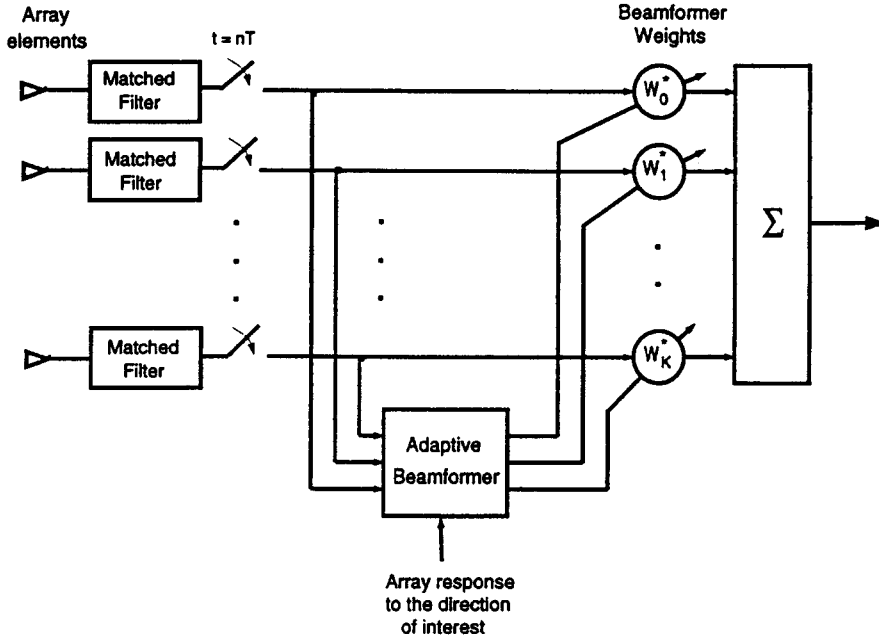

Fig. 2. Antenna array and beamformer.

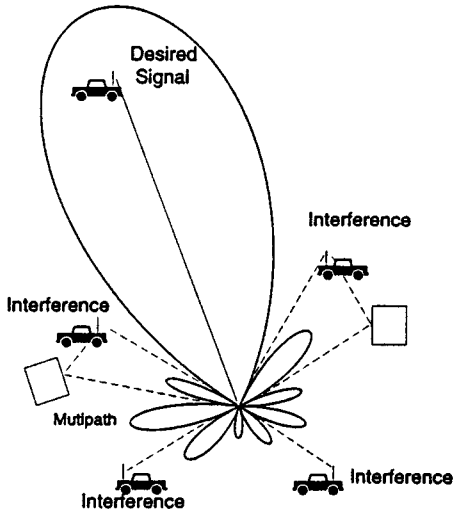

Fig. 3. Sample antenna array pattern.

### III. ANTENNA ARRAY AND BEAMFORMING

An adaptive antenna array consists of a set of antennas, designed to receive signals radiating from some specific directions and attenuate signals radiating from other directions of no interest. The outputs of array elements are weighted and added by a beamformer, as shown in Fig. 2, to produce a directed main beam and adjustable nulls. In order to reject the interference, the beamformer has to place its nulls in the directions of sources of interference, and steer to the direction of the target signal by maintaining constant gain at this direction. A sample antenna array pattern, which is depicted in Fig. 3, shows this effect.

Now, consider a cochannel set consisting of  $M$  transmitter and receiver pairs, and assume antenna arrays with  $K$  elements are used at the receivers. Denote the array response to the direction of arrival  $\theta$  by  $\mathbf{v}(\theta)$  defined as  $\mathbf{v}(\theta) =$

$[v^1(\theta), v^2(\theta), \dots, v^K(\theta)]$ , where  $v^k(\theta)$  is the response of the  $k$ th antenna element at the direction  $\theta$ . We consider multipath channels with negligible delay spreads. That is, the propagation delay in different paths is much smaller than a fraction of a symbol. Also, we assume slow fading channels in which the channel response can be assumed constant over several symbol intervals. Under the above assumptions, the received vector at the  $i$ th array can be written as

$$\mathbf{x}_i(t) = \sum_{j=1}^M \sqrt{P_j G_{ji}} \sum_{l=1}^L \alpha_{ji}^l \mathbf{v}_j(\theta_l) s_j(t - \tau_j) + \mathbf{n}_i(t)$$

where  $s_j(t)$  is the message signal transmitted from the  $j$ th user,  $\tau_j$  is the corresponding time delay,  $\mathbf{n}_i(t)$  is the thermal noise vector at the input of antenna array at the  $i$ th receiver, and  $P_j$  is the power of the  $j$ th transmitter.  $\mathbf{v}_j(\theta_l)$  is the response of the  $j$ th receiver array to the direction  $\theta_l$ . The attenuation due to shadowing in the  $l$ th path is denoted by  $\alpha_{ji}^l$ . Define the  $K \times 1$  vector  $\mathbf{a}_{ji}$ , called the *spatial signature* or *array response* of the  $i$ th antenna array to the  $j$ th source, as

$$\mathbf{a}_{ji} = \sum_{l=1}^L \alpha_{ji}^l \mathbf{v}_j(\theta_l). \quad (6)$$

The received signal at the  $i$ th receiver is given by

$$\mathbf{x}_i(t) = \sum_{j=1}^M \sqrt{P_j G_{ji}} \mathbf{a}_{ji} s_j(t - \tau_j) + \mathbf{n}_i(t). \quad (7)$$

In nonspread spectrum systems, the transmitted signal is given by

$$s_i(t) = \sum_n b_i(n) g(t - nT)$$

where  $b_i(n)$  is the  $i$ th user information bit stream and  $g(t)$  is the pulse-shaping filter impulse response. It has been shown

that the output of a matched filter sampled at the symbol intervals is a sufficient statistic for the estimation of the transmitted signal [18]. The matched filter is given by  $g^*(-t)$ . The output of the matched filter is sampled at  $t = nT$  (Fig. 2)

$$\mathbf{x}_i(n) = \mathbf{x}_i(t) * g^*(-t)|_{t=nT}.$$

Hence, the received signal at the output of the matched filter is given by

$$\mathbf{x}_i(n) = \sum_{j=1}^M \sqrt{P_j G_{ji}} \mathbf{a}_{ji} b_j(n) + \mathbf{n}_i(n)$$

where  $\mathbf{n}_i(n) = \mathbf{n}_i(t) * g^*(-t)|_{t=nT}$ . Consider the problem of beamforming as to maximize the SINR for a specific link, which is equivalent to minimizing the interference at the receiver of that link. In order to minimize the interference, we minimize the variance or average power at the output of the beamformer subject to maintaining unity gain at the direction of the desired signal. We can write the output of the beamformer at the  $i$ th receiver as

$$\mathbf{e}_i(n) = \mathbf{w}_i^H \mathbf{x}_i(n)$$

where  $\mathbf{w}_i$  and  $\mathbf{x}_i(n)$  are the beamforming weight vector and the received signal vector at the  $i$ th receiver, respectively. The average output power is given by

$$\begin{aligned} \mathcal{E}_i &= E\{\mathbf{w}_i^H \mathbf{x}_i(n) \mathbf{x}_i^H(n) \mathbf{w}_i\} \\ &= \mathbf{w}_i^H E\{\mathbf{x}_i(n) \mathbf{x}_i^H(n)\} \mathbf{w}_i \\ &= \mathbf{w}_i^H \Phi_i \mathbf{w}_i \end{aligned} \quad (8)$$

where  $\Phi_i$  is the correlation matrix of the received vector  $\mathbf{x}_i(n)$ . If the message signals  $s_j(t)$  are uncorrelated and zero mean, the correlation matrix  $\Phi_i$  is given by

$$\begin{aligned} \Phi_i &= \sum_{j \neq i} P_j G_{ji} \mathbf{a}_{ji} \mathbf{a}_{ji}^H + N_i \mathbf{I} + P_i G_{ii} \mathbf{a}_{ii} \mathbf{a}_{ii}^H \\ &= \Phi_{in} + P_i G_{ii} \mathbf{a}_{ii} \mathbf{a}_{ii}^H \end{aligned} \quad (9)$$

where

$$\Phi_{in} = \sum_{j \neq i} P_j G_{ji} \mathbf{a}_{ji} \mathbf{a}_{ji}^H + N_i \mathbf{I} \quad (10)$$

is the correlation matrix of unwanted signals, and  $N_i$  is the noise power at the input of each array element. Combining (8) and (9), we obtain the received signal plus interference power as a function of weight vector  $\mathbf{w}_i$

$$\mathcal{E}_i = P_i G_{ii} + \sum_{j \neq i} P_j G_{ji} \mathbf{w}_i^H \mathbf{a}_{ji} \mathbf{a}_{ji}^H \mathbf{w}_i + N_i \mathbf{w}_i^H \mathbf{w}_i. \quad (11)$$

Here, we use the fact that the gain at the direction of interest is unity, i.e.,  $\mathbf{w}_i^H \mathbf{a}_{ii} = 1$ . The first term in (11) is the received power from the signal of interest, while the other terms are related to the interference and noise. That is, the total interference is written as

$$I_i = \sum_{j \neq i} G_{ji} \mathbf{w}_i^H \mathbf{a}_{ji} \mathbf{a}_{ji}^H \mathbf{w}_i P_j + N_i \mathbf{w}_i^H \mathbf{w}_i.$$

The goal of beamforming is to find a weight vector  $\mathbf{w}_i$  that minimizes the interference  $I_i$  subject to  $\mathbf{w}_i^H \mathbf{a}_{ii} = 1$ . It can be shown that the unique solution to this problem is given by [15]

$$\hat{\mathbf{w}}_i = \frac{\Phi_{in}^{-1} \mathbf{a}_{ii}}{\mathbf{a}_{ii}^H \Phi_{in}^{-1} \mathbf{a}_{ii}}. \quad (12)$$

The antenna gain for the signal of interest is unity. As a result, the desired signal is unaffected by beamforming. The SINR at the  $i$ th receiver is then given by

$$\Gamma_i = P_i G_{ii} \mathbf{a}_{ii}^H \Phi_{in}^{-1} \mathbf{a}_{ii}. \quad (13)$$

In a spread spectrum system, the message signal is given by

$$s_i(t) = \sum_n b_i(n) c_i(t - nT) \quad (14)$$

where  $c(t)$  is the spreading sequence. The matched filter in a spread spectrum receiver is given by  $c^*(-t)$ . The received signal, sampled at the output of the matched filter, is expressed as

$$\begin{aligned} y_i(n) &= \int_{(n-1)T+\tau_i}^{nT+\tau_i} c_i(t - nT - \tau_i) \left( \sum_j \sqrt{P_j G_{ji}} \right. \\ &\quad \left. \cdot \sum_m b_j(m) c_j \cdot (t - mT - \tau_j) \mathbf{a}_{ji} + \mathbf{n}_i(t) \right) dt. \end{aligned}$$

We assume the signature sequences of the interfering users appear as mutually uncorrelated noise. The correlation matrix of the signal at the output of correlator is then given by [14]

$$\begin{aligned} \Phi_i &= E\{y_i(n) y_i^H(n)\} \\ &= \sum_{j \neq i} P_j G_{ji} \mathbf{a}_{ji} \mathbf{a}_{ji}^H + N_i \mathbf{I} + L P_i G_{ii} \mathbf{a}_{ii} \mathbf{a}_{ii}^H \\ &= \Phi_{in} + L P_i G_{ii} \mathbf{a}_{ii} \mathbf{a}_{ii}^H \end{aligned} \quad (15)$$

where  $L$  is the processing gain, and  $\Phi_{in}$  is defined as in (10). The optimum beamforming weight vector is similarly given by (12), and the maximum signal-to-noise ratio can be written as follows:

$$\Gamma_i = L P_i G_{ii} \mathbf{a}_{ii}^H \Phi_{in}^{-1} \mathbf{a}_{ii}. \quad (16)$$

Equations (13) and (16) are similar, but the latter includes the processing gain. For simplicity of notation, henceforth, we assume the processing gain is absorbed in  $\Gamma_i$ . Therefore, (13) can be used to express the SINR in both cases.

In order to calculate the received power for transmitter  $j$ , we have to multiply the transmitter power by the antenna power gain in addition to the propagation path gain, i.e.,

$$G_{ji} G_{a_i}(\mathbf{w}_i, \mathbf{a}_{ji})$$

where  $G_{a_i}(\mathbf{w}_i, \mathbf{a}_{ji}) = |\mathbf{w}_i^H \mathbf{a}_{ji}|^2$ . Then, the maximum SINR at the  $i$ th receiver can be written as

$$\Gamma_i = \frac{P_i G_{ii}}{\sum_{j \neq i} G_{ji} G_{a_i}(\hat{\mathbf{w}}_i, \mathbf{a}_{ji}) P_j + N_i \hat{\mathbf{w}}_i^H \hat{\mathbf{w}}_i} \quad (17)$$

where it is assumed that the array response to the source of interest, given by (6), is known. Knowing the response

vector  $\mathbf{v}_j(\theta)$  and the *direction of arrival* (DOA) for the signal of interest and its multipaths, we can calculate the array response from (6). In wireless networks, usually, the number of cochannels and multipath signals is much larger than the number of array elements. As a result, conventional DOA estimation methods like ESPRIT and MUSIC are not applicable. However, there exist some schemes that can be used to estimate the array response in nonspread spectrum [16], [17], and spread spectrum systems [14], without the need to estimate the DOA. Further, as we will see later when we use a training sequence, there is no need to estimate the array response.

#### IV. JOINTLY OPTIMAL POWER CONTROL AND BEAMFORMING

The level of cochannel interference at each receiver depends both on the gain between interfering transmitters and receivers, as well as on the level of transmitter powers, i.e., the optimal beamforming vector may vary for different powers. Hence, beamforming and power control should be considered jointly.

In the joint power control and beamforming problem, the objective is to find the optimal weight vector and power allocations such that the SINR threshold is achieved by all links, while each transmitter keeps the transmission power at the minimum required level to reduce the interference to other users. The SINR at the  $i$ th receiver is given by

$$\Gamma_i = \frac{P_i G_{ii}}{\sum_{j \neq i} G_{ji} G_{a_i}(\mathbf{w}_i, \mathbf{a}_{ji}) P_j + N_i \mathbf{w}_i^H \mathbf{w}_i}.$$

The optimization problem is defined as

$$\begin{aligned} \min_{\mathbf{W}, \mathbf{P}} \quad & \sum_{i=1}^M P_i \\ \text{subject to} \quad & \Gamma_i \geq \gamma_i, \quad i = 1, 2, \dots, M \end{aligned} \quad (18)$$

where  $\mathbf{W} = \{\mathbf{w}_1, \mathbf{w}_2, \dots, \mathbf{w}_M\}$  is a set of beamforming vectors, and  $\gamma_i$  is the minimum protection ratio for the  $i$ th link. This constraint can be presented in matrix form as

$$[\mathbf{I} - \mathbf{F}^w] \mathbf{P} \geq \mathbf{u}^w$$

where

$$[\mathbf{F}^w]_{ij} = \begin{cases} 0, & \text{if } j = i \\ \frac{\gamma_i G_{ji} G_{a_i}(\mathbf{w}_i, \mathbf{a}_{ji})}{G_{ii}} > 0, & \text{otherwise} \end{cases}$$

and  $\mathbf{u}^w$  is an element-wise positive vector with elements  $u_i$  defined as

$$u_i^w = \frac{\gamma_i N_i \mathbf{w}_i^H \mathbf{w}_i}{G_{ii}}, \quad i = 1, 2, \dots, M.$$

Assume that there is a set of weight vectors  $\mathbf{W}$ , for which  $\rho(\mathbf{F}^w) < 1$ . The matrix  $\mathbf{I} - \mathbf{F}^w$  is then invertible and  $\mathbf{P}_w = [\mathbf{I} - \mathbf{F}^w]^{-1} \mathbf{u}^w$  minimizes the objective function in the optimization problem for the fixed weight vector set  $\mathbf{W}$ . For any feasible  $\mathbf{W}$ , the vector  $\mathbf{P}_w$  can be computed as the limit of the following iteration:

$$\begin{aligned} P_i^{n+1} = \sum_{j \neq i} \frac{\gamma_i G_{ji} G_{a_i}(\mathbf{w}_i, \mathbf{a}_{ji})}{G_{ii}} P_j^n + \frac{\gamma_i N_i \mathbf{w}_i^H \mathbf{w}_i}{G_{ii}}, \\ i = 1, 2, \dots, M. \end{aligned} \quad (19)$$

The above iteration is similar to the distributed power control algorithm (see [6]–[9]), in which the link gain  $G_{ji}$  is replaced by the multiplication of the path loss and antenna gain, and the noise power is replaced by the weighted sum of the noise powers at the inputs of array elements. Denote the iteration in (19) as

$$\mathbf{P}^n = m^w(\mathbf{P}^{n-1}).$$

Starting from any initial power vector  $\mathbf{P}^0$ , the mapping  $m^w$  will converge to the optimal power vector  $\mathbf{P}_w$  which is the fixed point of the mapping, i.e.,  $\lim_{n \rightarrow \infty} \mathbf{P}^n = \mathbf{P}_w$ ,  $\mathbf{P}_w = m^w(\mathbf{P}_w)$ . The objective in the joint beamforming and power control problem is to find the beamforming set  $\mathbf{W}$  among all feasible beamforming sets, in such a way that  $\mathbf{P}_w$  is minimal. In order to find the optimal solution for the minimization problem  $\hat{\mathbf{P}}$ , we define the  $i$ th element of the mapping  $m$  as

$$\begin{aligned} m_i(\hat{\mathbf{P}}) = \min_{\mathbf{w}_i} \left\{ \sum_{j \neq i} \frac{\gamma_i G_{ji} G_{a_i}(\mathbf{w}_i, \mathbf{a}_{ji})}{G_{ii}} \hat{P}_j + \frac{\gamma_i N_i \mathbf{w}_i^H \mathbf{w}_i}{G_{ii}} \right\} \\ \text{subject to } \mathbf{w}_i^H \mathbf{a}_{ii} = 1, \quad i = 1, 2, \dots, M. \end{aligned} \quad (20)$$

In the following, we show that the optimum power allocation is the fixed point of mapping  $m$ , i.e.,

$$\hat{\mathbf{P}} = m(\hat{\mathbf{P}}).$$

The following lemma holds for mapping  $m$ .

*Lemma 1:* The fixed point of mapping  $m$  and the optimal beamforming weight vectors are unique.

*Proof:* The uniqueness can be shown by a similar approach as in [10]. Assume positive power vectors  $\hat{\mathbf{P}}$  and  $\mathbf{P}^*$  are the fixed points of the mappings. Without loss of generality, assume for the  $k$ th element of these two vectors the following relationship holds:  $\hat{P}_k > P_k^*$ . Let  $\alpha = \max_l (\hat{P}_l / P_l^*) > 1$ , such that  $\alpha \mathbf{P}^* \geq \hat{\mathbf{P}}$ . We can find an index  $i$  such that  $\alpha P_i^* = \hat{P}_i$ . Since both  $\hat{\mathbf{P}}$  and  $\mathbf{P}^*$  are the fixed points of mapping  $m$ ,

$$\begin{aligned} \hat{P}_i &= \min_{\mathbf{w}_i} \left\{ \sum_{j \neq i} \frac{\gamma_i G_{ji} G_{a_i}(\mathbf{w}_i, \mathbf{a}_{ji})}{G_{ii}} \hat{P}_j + \frac{\gamma_i N_i \mathbf{w}_i^H \mathbf{w}_i}{G_{ii}} \right\} \\ &\text{subject to } \mathbf{w}_i^H \mathbf{a}_{ii} = 1 \\ &\leq \min_{\mathbf{w}_i} \left\{ \sum_{j \neq i} \frac{\gamma_i G_{ji} G_{a_i}(\mathbf{w}_i, \mathbf{a}_{ji})}{G_{ii}} \alpha P_j^* + \frac{\gamma_i N_i \mathbf{w}_i^H \mathbf{w}_i}{G_{ii}} \right\} \\ &\text{subject to } \mathbf{w}_i^H \mathbf{a}_{ii} = 1 \\ &< \alpha \left( \min_{\mathbf{w}_i} \left\{ \sum_{j \neq i} \frac{\gamma_i G_{ji} G_{a_i}(\mathbf{w}_i, \mathbf{a}_{ji})}{G_{ii}} P_j^* \right. \right. \\ &\quad \left. \left. + \frac{\gamma_i N_i \mathbf{w}_i^H \mathbf{w}_i}{G_{ii}} \right\} \right) \\ &\text{subject to } \mathbf{w}_i^H \mathbf{a}_{ii} = 1 \\ &= \alpha P_i^*. \end{aligned} \quad (21)$$

The above contradiction implies that the fixed point of mapping  $m$  is unique. The optimal weight vectors are given by

$$\hat{\mathbf{w}}_i = \arg \min_{\mathbf{w}_i} \left\{ \sum_{j \neq i} \frac{\gamma_i G_{ji} G_{a_i}(\mathbf{w}_i, \mathbf{a}_{ji})}{G_{ii}} \hat{P}_j + \frac{\gamma_i N_i \mathbf{w}_i^H \mathbf{w}_i}{G_{ii}} \right\}$$

subject to  $\mathbf{w}_i^H \mathbf{a}_{ii} = 1, \quad (i = 1, 2, \dots, M). \quad (22)$

Since the solution to the optimal beamforming problem, given by (12), is unique [15], the optimal weight vectors are also unique which are denoted by a set  $\hat{\mathbf{W}} = \{\hat{\mathbf{w}}_1, \dots, \hat{\mathbf{w}}_M\}$ .  $\square$

Let  $(\hat{\mathbf{P}}, \hat{\mathbf{W}})$  be the power vector and the weight vector set which achieve the minimum in (18). In the following, we present an iterative algorithm for adjusting  $\mathbf{P}$  and  $\mathbf{W}$  simultaneously, and we will show that, starting from any arbitrary power vector, it converges to the optimal solution  $(\hat{\mathbf{P}}, \hat{\mathbf{W}})$ . The iteration step for obtaining  $(\mathbf{P}^{n+1}, \mathbf{W}^{n+1})$  given  $\mathbf{P}^n$  is as follows.

*Algorithm A*

1)  $\mathbf{w}_i^{n+1}$  is computed at each receiver  $i$  such that the cochannel interference is minimized under the constraint of maintaining constant gain for the direction of interest, i.e.,

$$\mathbf{w}_i^{n+1} = \arg \min_{\mathbf{w}_i} \left\{ \sum_{j \neq i} G_{ji} G_{a_i}(\mathbf{w}_i, \mathbf{a}_{ji}) P_j^n + N_i \mathbf{w}_i^H \mathbf{w}_i \right\}$$

$(i = 1, 2, \dots, M)$   
subject to  $\mathbf{w}_i^H \mathbf{a}_{ii} = 1$

where  $\mathbf{P}^n$  is the power vector updated at the  $(n-1)$ th step.

2) The updated power vector,  $\mathbf{P}^{n+1}$ , is then obtained by

$$P_i^{n+1} = \sum_{j \neq i} \frac{\gamma_i G_{ji} G_{a_i}(\mathbf{w}_i^{n+1}, \mathbf{a}_{ji})}{G_{ii}} P_j^n + \frac{\gamma_i N_i (\mathbf{w}_i^{n+1})^H \mathbf{w}_i^{n+1}}{G_{ii}}$$

by performing one iteration with the mapping  $m^{\mathbf{w}_i^{n+1}}$  on the power vector  $\mathbf{P}^n$ .

Combining two iteration steps in the algorithm, we obtain the power vector update in a single step

$$P_i^{n+1} = \min_{\mathbf{w}_i} \left\{ \sum_{j \neq i} \frac{\gamma_i G_{ji} G_{a_i}(\mathbf{w}_i, \mathbf{a}_{ji})}{G_{ii}} P_j^n + \frac{\gamma_i N_i \mathbf{w}_i^H \mathbf{w}_i}{G_{ii}} \right\}$$

subject to  $\mathbf{w}_i^H \mathbf{a}_{ii} = 1 \quad (23)$

which is expressed as

$$\mathbf{P}^{n+1} = m(\mathbf{P}^n).$$

*Theorem 1:* The sequence  $(\mathbf{P}^n, \mathbf{W}^n)$ ,  $(n = 1, 2, \dots)$  produced by the iteration (23), starting from an arbitrary power  $\mathbf{P}^0$ , converges to the optimal pair  $(\hat{\mathbf{P}}, \hat{\mathbf{W}})$ .

In order to prove *Theorem 1*, first we will present a lemma, and then we will show that the theorem holds when the iteration starts from the power vector  $\mathbf{P}^0 = 0$ .

*Lemma 2:* For any two power vectors  $\mathbf{P}_1$  and  $\mathbf{P}_2$  such that  $\mathbf{P}_1 \leq \mathbf{P}_2$  the following holds:

- a)  $m(\mathbf{P}_1) \leq m^{\mathbf{W}}(\mathbf{P}_1), \quad \forall \mathbf{W};$
- b)  $m^{\mathbf{W}}(\mathbf{P}_1) \leq m^{\mathbf{W}}(\mathbf{P}_2), \quad \forall \mathbf{W};$
- c)  $m(\mathbf{P}_1) \leq m(\mathbf{P}_2).$

*Proof:* Point a) holds, since in the mapping  $m$ , we are minimizing the power vector  $\mathbf{P}$  over all possible weight vectors  $\mathbf{W}$ , b) can be concluded immediately from the fact that the coefficients in the mapping  $m^{\mathbf{W}}$  are positive, and c) can be shown as follows:

$$m(\mathbf{P}_2) = m^{\hat{\mathbf{W}}}(\mathbf{P}_2).$$

Since  $\mathbf{P}_1 \leq \mathbf{P}_2$ , from b) we conclude

$$m(\mathbf{P}_2) \geq m^{\hat{\mathbf{W}}}(\mathbf{P}_1)$$

and from a),

$$m(\mathbf{P}_2) \geq m(\mathbf{P}_1). \quad \square$$

*Theorem 2:* The sequence  $\mathbf{P}^n$ , generated by iteration (23) and initial condition  $\mathbf{P}^0 = 0$ , converges to the fixed point of the mapping  $m$ ,  $\hat{\mathbf{P}}$ .

*Proof:* We define two power vector sequences  $\mathbf{P}^n$  and  $\mathbf{P}_{\hat{\mathbf{W}}}^n$  produced by the mappings  $m$  and  $m^{\hat{\mathbf{W}}}$ , respectively, with zero initial condition. That is,

$$\mathbf{P}^{n+1} = m(\mathbf{P}^n), \quad \mathbf{P}^0 = \mathbf{0}$$

and

$$\mathbf{P}_{\hat{\mathbf{W}}}^{n+1} = m^{\hat{\mathbf{W}}}(\mathbf{P}_{\hat{\mathbf{W}}}^n), \quad \mathbf{P}_{\hat{\mathbf{W}}}^0 = \mathbf{0}.$$

The power vector sequence  $\mathbf{P}^n$  is nondecreasing. In order to show this, we observe that  $\mathbf{P}^1 = m(\mathbf{P}^0) = \mathbf{u}^{\mathbf{W}} \geq 0$ , i.e.,  $\mathbf{P}^0 \leq \mathbf{P}^1$ , and if  $\mathbf{P}^{n-1} \leq \mathbf{P}^n$ , *Lemma 2 c)* implies  $m(\mathbf{P}^{n-1}) \leq m(\mathbf{P}^n)$  or  $\mathbf{P}^n \leq \mathbf{P}^{n+1}$ . By induction, we conclude that  $\mathbf{P}^n$  is a nondecreasing sequence.

We start the mappings  $m$  and  $m^{\hat{\mathbf{W}}}$  from the same starting vector  $\mathbf{P}^0 = \mathbf{P}_{\hat{\mathbf{W}}}^0 = \mathbf{0}$ . We can follow the same steps to prove that the sequence  $\mathbf{P}_{\hat{\mathbf{W}}}^n$  is also nondecreasing. Since  $\hat{\mathbf{W}}$  is the optimal beamforming set, the sequence  $\mathbf{P}_{\hat{\mathbf{W}}}^n$  will converge to the optimal power vector  $\hat{\mathbf{P}}$ , i.e.,

$$\lim_{n \rightarrow \infty} \mathbf{P}_{\hat{\mathbf{W}}}^n = \hat{\mathbf{P}}.$$

By *Lemma 2 a)*,  $m(\mathbf{P}^0) \leq m^{\hat{\mathbf{W}}}(\mathbf{P}_{\hat{\mathbf{W}}}^0)$  or  $\mathbf{P}^1 \leq \mathbf{P}_{\hat{\mathbf{W}}}^1$ , and if  $\mathbf{P}^n \leq \mathbf{P}_{\hat{\mathbf{W}}}^n$ , by *Lemma 2 a)* and b),  $m(\mathbf{P}^n) \leq m^{\hat{\mathbf{W}}}(\mathbf{P}_{\hat{\mathbf{W}}}^n)$  or  $\mathbf{P}^{n+1} \leq \mathbf{P}_{\hat{\mathbf{W}}}^{n+1}$  for all  $n$ . That is, by induction we may write  $\mathbf{P}^n \leq \mathbf{P}_{\hat{\mathbf{W}}}^n$ , (for  $n = 1, 2, \dots$ ). Hence,  $\mathbf{P}^n$  is a nondecreasing sequence and bounded from above by  $\hat{\mathbf{P}}$ , so it has a limit denoted by  $\mathbf{P}^*$ . Since the mapping  $m$  is continuous,  $\mathbf{P}^* = \lim_{n \rightarrow \infty} \mathbf{P}^n = m(\lim_{n \rightarrow \infty} \mathbf{P}^n) = m(\mathbf{P}^*)$ . That is, the power vector  $\mathbf{P}^*$  is the fixed point of the mapping  $m$ . It is shown in the following that  $\mathbf{P}^* = \hat{\mathbf{P}}$ . Let

$$P_i^* = \min_{\mathbf{w}_i} \left\{ \sum_{j \neq i} G_{ji} G_{a_i}(\mathbf{w}_i, \mathbf{a}_{ji}) P_j^* + N_i \mathbf{w}_i^H \mathbf{w}_i \right\},$$

$i = 1, 2, \dots, M$   
subject to  $\mathbf{w}_i^H \mathbf{a}_{ii} = 1.$

By definition,  $\mathbf{P}^* = \hat{\mathbf{P}}$ . That is, the sequence  $\mathbf{P}^n$  converges to the optimal power vector  $\hat{\mathbf{P}}$ . Since the power vector is converging to  $\hat{\mathbf{P}}$ , beamforming vectors are also converging to  $(\tilde{\mathbf{w}}_i, i = 1, \dots, M)$  given by

$$\tilde{\mathbf{w}}_i = \min_{\mathbf{w}_i} \left\{ \sum_{j \neq i} G_{ji} G_{a_i}(\mathbf{w}_i, \mathbf{a}_{ji}) \hat{P}_j + N_i \mathbf{w}_i^H \mathbf{w}_i \right\},$$

$$i = 1, 2, \dots, M.$$

The uniqueness of the optimal beamforming weight vectors implies  $\tilde{\mathbf{w}}_i = \hat{\mathbf{w}}_i$ , ( $i = 1, 2, \dots, M$ ).  $\square$

*Proof of Theorem 1:* Now we will show that a power vector sequence starting from any initial power vector converges to the optimal power vector  $\hat{\mathbf{P}}$ . We consider the sequence  $\tilde{\mathbf{P}}^{n+1} = m(\tilde{\mathbf{P}}^n)$  with the arbitrary initial power vector  $\tilde{\mathbf{P}}^0$ .

Assume there exists a feasible pair  $(\hat{\mathbf{P}}, \hat{\mathbf{W}})$ . The power vector iteration for this pair is given by

$$\mathbf{P}_{\tilde{\mathbf{w}}}^{n+1} = m^{\tilde{\mathbf{w}}}(\mathbf{P}_{\tilde{\mathbf{w}}}^n), \quad n = 0, 1, \dots \quad (24)$$

The optimality of  $\hat{\mathbf{W}}$  implies that  $\lim_{n \rightarrow \infty} \mathbf{P}_{\tilde{\mathbf{w}}}^n = \hat{\mathbf{P}}$ , where  $\hat{\mathbf{P}}$  is the fixed point of the mapping defined in (24). Assume that both sequences start from the same point, i.e.,  $\tilde{\mathbf{P}}^0 = \mathbf{P}_{\tilde{\mathbf{w}}}^0$ . Lemma 2 a) implies  $m(\tilde{\mathbf{P}}^0) \leq m^{\tilde{\mathbf{w}}}(\mathbf{P}_{\tilde{\mathbf{w}}}^0)$  or  $\tilde{\mathbf{P}}^1 \leq \mathbf{P}_{\tilde{\mathbf{w}}}^1$ . If  $\tilde{\mathbf{P}}^n \leq \mathbf{P}_{\tilde{\mathbf{w}}}^n$ , then  $m(\tilde{\mathbf{P}}^n) \leq m^{\tilde{\mathbf{w}}}(\mathbf{P}_{\tilde{\mathbf{w}}}^n)$  or  $\tilde{\mathbf{P}}^{n+1} \leq \mathbf{P}_{\tilde{\mathbf{w}}}^{n+1}$ . Hence, by induction, we have

$$\tilde{\mathbf{P}}^n \leq \mathbf{P}_{\tilde{\mathbf{w}}}^n, \quad n = 0, 1, \dots$$

and since  $\lim_{n \rightarrow \infty} \mathbf{P}_{\tilde{\mathbf{w}}}^n = \hat{\mathbf{P}}$ , we have  $\tilde{\mathbf{P}}^n \leq \hat{\mathbf{P}}$ , ( $n = 0, 1, \dots$ ). That is, the sequence  $\tilde{\mathbf{P}}^n$  is bounded; therefore, it has accumulation points. For any accumulation point  $\tilde{\mathbf{P}}^*$ , the following inequality holds:

$$\tilde{\mathbf{P}}^* \leq \hat{\mathbf{P}}. \quad (25)$$

Let the sequence  $\check{\mathbf{P}}^n$  defined by the iteration  $\check{\mathbf{P}}^n = m(\check{\mathbf{P}}^{n-1})$  start from  $\check{\mathbf{P}}^0 = 0$ . Lemma 2 c) implies  $m(\check{\mathbf{P}}^0) \leq m(\tilde{\mathbf{P}}^0)$ , that is,  $\check{\mathbf{P}}^1 \leq \tilde{\mathbf{P}}^1$ . If  $\check{\mathbf{P}}^n \leq \tilde{\mathbf{P}}^n$ , then  $m(\check{\mathbf{P}}^n) \leq m(\tilde{\mathbf{P}}^n)$  or  $\check{\mathbf{P}}^{n+1} \leq \tilde{\mathbf{P}}^{n+1}$ . By induction, we may write

$$\check{\mathbf{P}}^n \leq \tilde{\mathbf{P}}^n, \quad n = 0, 1, \dots$$

From Theorem 2, it follows that the sequence  $\check{\mathbf{P}}$  converges to  $\hat{\mathbf{P}}$ ; therefore, for the accumulation points, we have

$$\check{\mathbf{P}}^* = \hat{\mathbf{P}} \leq \tilde{\mathbf{P}}^*. \quad (26)$$

The inequalities (25) and (26) imply that  $\tilde{\mathbf{P}}^* = \hat{\mathbf{P}}$ .  $\square$

The proofs of Theorems 1 and 2 can be done by the standard function approach [11]. In practice, Algorithm A is implemented as follows.

- 1) The received signal correlation matrix is calculated at the base station  $\Phi_i = E\{\mathbf{x}_i \mathbf{x}_i^H\}$ .
- 2) The optimal weight vectors  $\mathbf{w}_i, i = 1, \dots, N$  are calculated and the total interference is sent to the mobile.
- 3) Mobile updates its power based on the total interference and link gain, according to the following iteration:

$$P_i^{n+1} = \frac{\gamma_i}{G_{ii}} \{ \mathbf{w}_i^H (\Phi_i) \mathbf{w}_i - x P_i G_{ii} \}$$

where  $x = 1$  for nonspread spectrum systems, and  $x = L$  (the processing gain) in spread spectrum systems.

In order to calculate the optimal weight vector, we need to estimate the array response from each mobile to its base station. Assume that, because of estimation errors, the array response from the  $i$ th mobile to the  $i$ th base station is estimated as  $\tilde{\mathbf{a}}_{ii}$ . Note that there is no need to estimate the array response  $\mathbf{a}_{ij}, i \neq j$ , for those terms only appear in the interference measured at each base station. The optimal weight vector is given by

$$\tilde{\mathbf{w}}_i = \frac{\Phi_{in}^{-1} \tilde{\mathbf{a}}_{ii}}{\tilde{\mathbf{a}}_{ii}^H \Phi_{in}^{-1} \tilde{\mathbf{a}}_{ii}}. \quad (27)$$

Replacing  $\Phi_i$  from (9) or (15), we express the algorithm as

$$P_i^{n+1} = \min_{\mathbf{w}_i} \left\{ \gamma_i \left( \sum_{j \neq i} \frac{G_{ji} G_{a_i}(\mathbf{w}_i, \mathbf{a}_{ji})}{G_{ii}} P_j^n + \frac{N_i \mathbf{w}_i^H \mathbf{w}_i}{G_{ii}} + x P_i (|\mathbf{w}_i^H \tilde{\mathbf{a}}_{ii}|^2 - 1) \right) \right\}$$

subject to  $\mathbf{w}_i^H \tilde{\mathbf{a}}_{ii} = 1$  (28)

and the signal-to-noise ratio at each link would be given by

$$\Gamma_i = \frac{|\tilde{\mathbf{w}}_i^H \tilde{\mathbf{a}}_{ii}|^2 P_i G_{ii}}{\sum_{j \neq i} G_{ji} P_j |\tilde{\mathbf{w}}_i^H \tilde{\mathbf{a}}_{ji}|^2 + N_i |\tilde{\mathbf{w}}_i|^2}.$$

Note that in spread spectrum systems, the processing gain is also included in  $\Gamma_i$  and  $\gamma_i$ . The array response estimation error will change the gain matrix and it may affect the feasibility of the network if the number of users is close to the maximum capacity of the network. It will also degrade the SINR at each link.

If the array response is not available, or the estimation error is large, we use a training sequence which is correlated with the desired signal. The weight vector is obtained by minimizing the difference of the estimated signal and the training sequence [15]. The minimization problem is defined as

$$\hat{\mathbf{w}}_i = \arg \min_{\mathbf{w}_i} E\{|d_i - \mathbf{w}_i^H \mathbf{x}_i|^2\}$$

and

$$E_{i, \min} = \min_{\mathbf{w}_i} E\{|d_i - \mathbf{w}_i^H \mathbf{x}_i|^2\}.$$

The solution to the above minimization problem is given by [15]

$$\hat{\mathbf{w}}_i = \Phi_i^{-1} \mathbf{p}_i$$

where the cross correlation  $\mathbf{p}_i$  is given by

$$\mathbf{p}_i = E\{\mathbf{x}_i d_i^*\}.$$

If we assume the training sequence is simply chosen as a copy of the message signal, the cross-correlation vector  $\mathbf{p}_i$  is expressed as

$$\mathbf{p}_i = \sqrt{P_i G_{ii}} \mathbf{a}_{ii}.$$

The optimal weight vector is then given by

$$\hat{\mathbf{w}}_i = \sqrt{P_i G_{ii}} \Phi_i^{-1} \mathbf{a}_{ii}. \quad (29)$$

The above method, known as optimum combining, will result in a similar solution as MVDR. It can be shown that the above method also maximizes the SINR. As a result, using the same approach, we can prove the convergence of the joint power control and optimum combining. However, in this method, there is no need to estimate the array response. The power control update is given by [20]

$$P_i^{n+1} = P_i^n \frac{\gamma_i}{\Gamma_i} = \gamma_i P_i^n \frac{E_{i, \min}}{1 - E_{i, \min}}. \quad (30)$$

Therefore, in order to update the transmitted power,  $E_{i, \min}$  is evaluated at each base station (measured locally) and sent to the assigned mobile. Knowing its previous transmitted power and the target SINR, the mobile will update its power according to (30).

### V. JOINT POWER CONTROL, BASE STATION ASSIGNMENT, AND BEAMFORMING

So far, we have considered the power control problem for a number of transmitter-receiver pairs with fixed assignments, which can be used in uplink or downlink in mobile communication systems. In the uplink power control problem without beamforming, the power allocation and base station assignment can be integrated to attain higher capacity, while achieving smaller power allocated to each mobile, as it has been demonstrated in previous studies [10], [12].

In the joint power control and base station assignment, a number of base stations are potential receivers of a mobile transmitter. Here, the objective is to determine the assignment of users to base stations which minimizes the allocated mobile powers. Iterative algorithms that compute the joint optimal base station and power assignment were proposed in [10] and [12].

In an uplink scenario where base stations are equipped with antenna arrays, the problem of joint power control and beamforming, as well as base station assignment, naturally arises. We will modify *Algorithm A* to support base station assignment as well. The modified algorithm can be summarized as follows.

#### Algorithm B:

1) Each base station in the allowable set of a mobile  $i$  minimizes the total interference subject to maintaining unity gain toward the direction of the  $i$ th mobile

$$\begin{aligned} \mathbf{w}_{im}^{n+1} = \arg \min_{\mathbf{w}_i} & \left\{ \sum_{j \neq m} G_{jm} G_{a_i}(\mathbf{w}_i, \mathbf{a}_{jm}) P_j^n \right. \\ & \left. + N_m \mathbf{w}_i^H \mathbf{w}_i \right\}, \quad i = 1, 2, \dots, M; m \in B_i \\ \text{subject to} & \quad \mathbf{w}_i^H \mathbf{a}_{im} = 1 \end{aligned}$$

where  $\mathbf{w}_{im}^{n+1}$  is the optimal beamforming weight vector at the  $m$ th base station for the  $i$ th mobile, and  $B_i$  is the set of allowable base stations for the  $i$ th mobile.

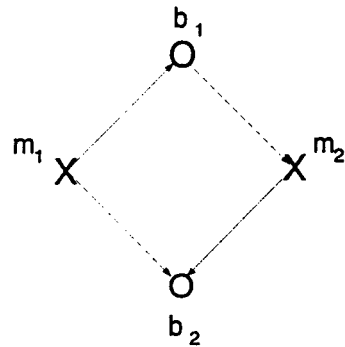

Fig. 4. A simple degenerate network.

2) Each mobile finds the optimal base station such that the allocated power for the next iteration is minimized

$$b_i = \arg \min_{j \in B_i} \left\{ \gamma_i \sum_{k \neq i} \frac{G_{kj} G_{a_i}(\mathbf{w}_{ij}^{n+1}, \mathbf{a}_{kj})}{G_{ij}} P_k^n + \frac{\gamma_i N_j \mathbf{w}_{ij}^{n+1 H} \mathbf{w}_{ij}^{n+1}}{G_{ij}} \right\}, \quad i = 1, 2, \dots, M$$

where  $b_i$  is the optimal assignment for mobile  $i$ .

3) Each mobile updates its transmitted power based on the optimum beamforming and base station assignment

$$P_i^{n+1} = \gamma_i \sum_{k \neq i} \frac{G_{kb_i} G_{a_i}(\mathbf{w}_{ib_i}^{n+1}, \mathbf{a}_{kb_i})}{G_{ib_i}} P_k^n + \frac{\gamma_i N_{b_i} \mathbf{w}_{ib_i}^{n+1 H} \mathbf{w}_{ib_i}^{n+1}}{G_{ib_i}}, \quad i = 1, 2, \dots$$

The above steps are combined in one iteration, denoted by  $\tilde{m}_i$

$$\begin{aligned} P_i^{n+1} = \tilde{m}_i(P_i^n) = \min_{\mathbf{w}_{ij}, j \in B_i} & \left\{ \gamma_i \sum_{k \neq i} \frac{G_{kj} G_{a_i}(\mathbf{w}_{ij}, \mathbf{a}_{kj})}{G_{ij}} P_k^n \right. \\ & \left. + \frac{\gamma_i N_j \mathbf{w}_{ij}^H \mathbf{w}_{ij}}{G_{ij}} \right\}, \quad i = 1, 2, \dots, M \\ \text{subject to} & \quad \mathbf{w}_{ij}^H \mathbf{a}_{ij} = 1. \end{aligned} \quad (31)$$

Consider a set of base station assignments by  $\mathbf{B} = \{b_1, \dots, b_M\}$ . Define the  $i$ th element of the mapping  $\tilde{m}^{w, b}$  as

$$\begin{aligned} P_i^{n+1} = \tilde{m}_i^{w, b}(P_i^n) \\ = \left\{ \gamma_i \sum_{k \neq i} \frac{G_{kb_i} G_{a_i}(\mathbf{w}_{ib_i}, \mathbf{a}_{kb_i})}{G_{ib_i}} P_k^n \right. \\ \left. + \frac{\gamma_i N_{b_i} \mathbf{w}_{ib_i}^H \mathbf{w}_{ib_i}}{G_{ib_i}} \right\}, \quad i = 1, 2, \dots, M \\ \text{subject to} \quad \mathbf{w}_i^H \mathbf{a}_{ib_i} = 1. \end{aligned} \quad (32)$$

The following lemma holds for  $\tilde{m}$  and  $\tilde{m}^{w, b}$ .



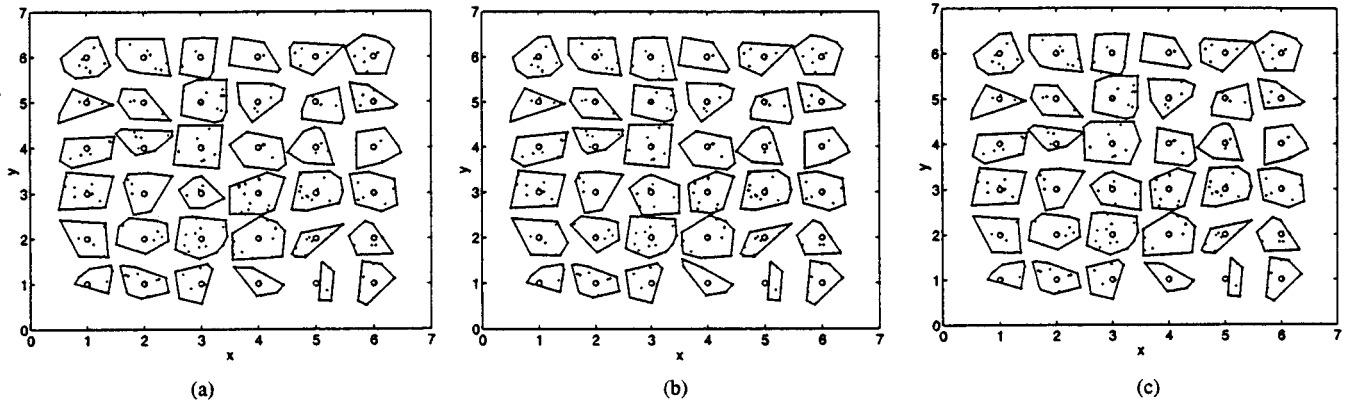

Fig. 5. Mobile and base stations locations for 400 users. (a) Traditional assignment. (b) Optimal base station and power control. (c) Optimal base station, beamforming, and power control.

**Lemma 3:** For any two power vectors  $\mathbf{P}_1$  and  $\mathbf{P}_2$  such that  $\mathbf{P}_1 \leq \mathbf{P}_2$  the following holds:

- $\tilde{m}(\mathbf{P}_1) \leq \tilde{m}^{w,B}(\mathbf{P}_1), \forall \mathbf{W}, \mathbf{B};$
- $\tilde{m}^{w,b}(\mathbf{P}_1) \leq \tilde{m}^{w,B}(\mathbf{P}_2), \forall \mathbf{w}, \mathbf{B};$
- $\tilde{m}(\mathbf{P}_1) \leq \tilde{m}(\mathbf{P}_2).$

Similar to the joint beamforming and power control case, we can show that *Theorems 1* and *2* hold for mapping  $\tilde{m}$  and *Algorithm B* converges to the optimal power allocation starting from any initial power vector.

In practice, each mobile can be assigned to a set of base stations, denoted by  $B_i$  for the  $i$ th mobile. At each iteration all of the base stations in the set will perform beamforming and the mobile transmitted power for the next iteration is calculated. The base station assignment or, in other words, the handoff, is performed by comparing the power requirements for different base station assignments. The base station with the least required power will be chosen for the mobile. It is worthwhile to note that the beamformings at the base stations are done independently, without the knowledge of other channel responses.

We have shown that the solution to the joint power control and beamforming is unique. In the joint problem with base station assignment, using the same approach as in *Lemma 1*, we can show that the optimal power allocation is also unique. However, the optimal base station and beamforming vectors may not be unique. In practice, the probability of nonuniqueness is almost zero and, if it happens, it will be lost by a slight variation in parameters. As a simple example, consider Fig. 4. Assume mobiles  $m_1$  and  $m_2$  are assigned to  $b_1$  and  $b_2$ , respectively. In this case, the optimal power allocation is given by  $P_1 = P_2 = P$ . Because of symmetry of the network, the same power vector can achieve the required signal-to-noise ratio at each link when  $m_1$  is assigned to  $b_2$  and  $m_2$  is assigned to  $b_1$ . In the latter case, the beamforming vectors are different, although the same optimal power vector can be achieved.

## VI. SIMULATION RESULTS AND COMPARISONS

We evaluate the performance of our algorithm by simulating the same system as in [12]. The quality constraint is considered to be 0.0304, which is equivalent to SINR of  $-14$  dB. This

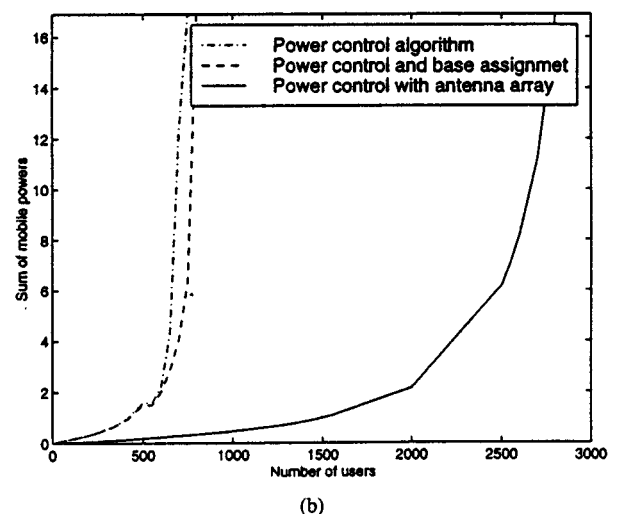
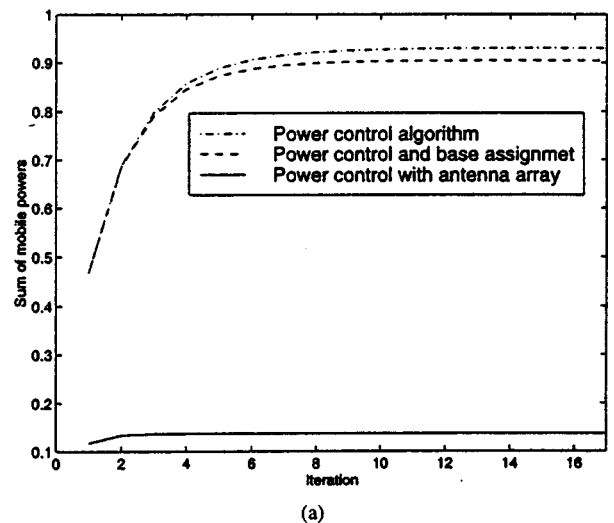

Fig. 6. (a) Total mobile powers versus the iteration number. (b) Total mobile powers versus the number of users.

threshold results in acceptable bit error rate only in CDMA systems where there is a processing gain of the order of 128 or more. However, the same methodology can be applied to any wireless network, such as TDMA and FDMA. In the latter cases, the interference rejection capability of antenna arrays can be utilized to decrease the reuse distance or support more

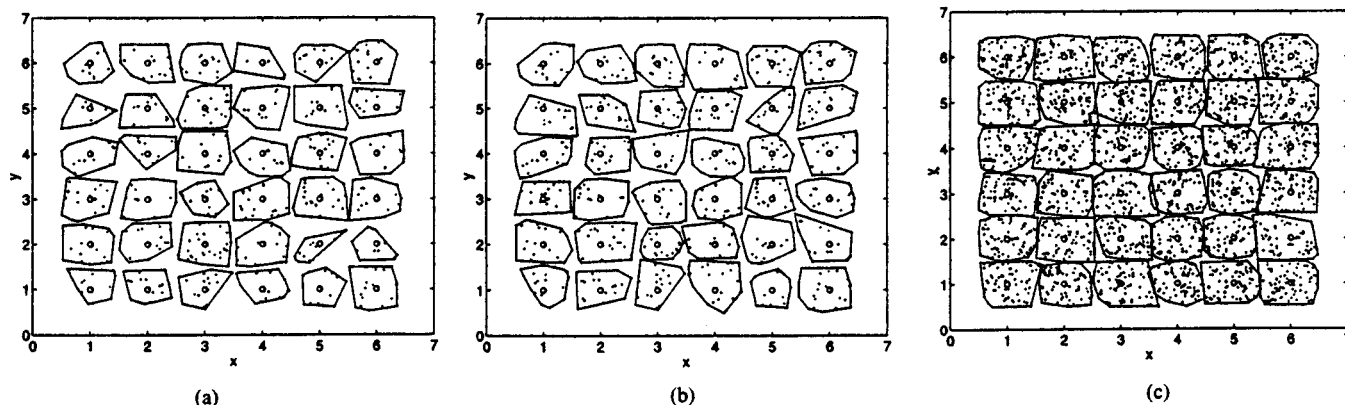

Fig. 7. Mobile and base stations locations. (a) Traditional assignment with 660 mobiles. (b) Optimal base station and power control with 800 mobiles. (c) Optimal base station, beamforming, and power control with 2800 mobiles.

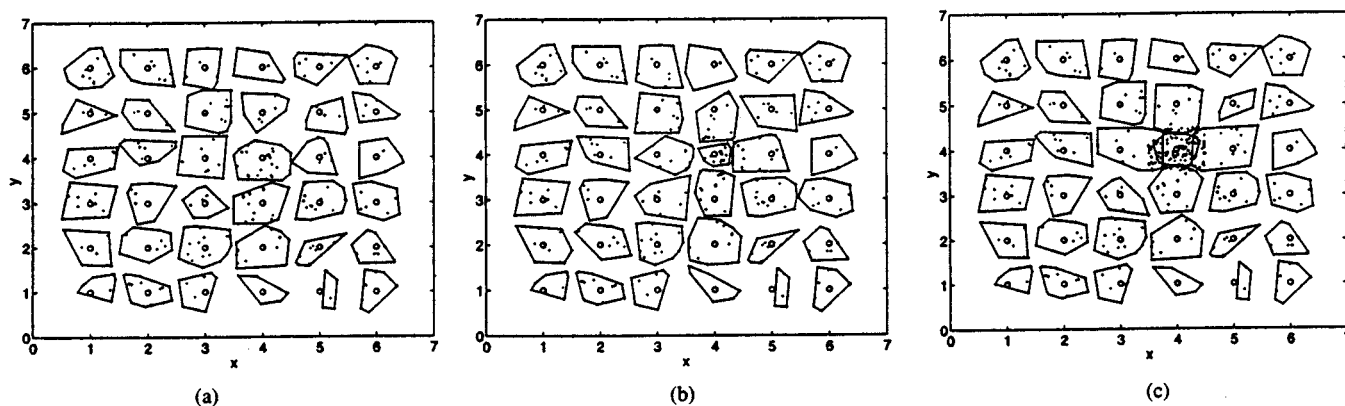

Fig. 8. Mobile and base stations locations with local congested area. (a) Traditional assignment with 22 additional users. (b) Optimal base station and power control with 57 additional users. (c) Optimal base station, beamforming, and power control with 150 additional users.

than one user with the same time slot or frequency in each cell. Both of these effects will increase the capacity significantly.

Fig. 5 shows a network with 36 base stations with 400 users randomly distributed in the area  $[0.5, 6.5] \times [0.5, 6.5]$  with uniform distribution. The link gain is modeled as  $G_{ij} = 1/d_{ij}^4$ , where  $d_{ij}$  is the distance between base  $i$  and mobile  $j$ . Throughout the simulations, we consider two system setups. In System Setup I, we use omnidirectional antennas; in System Setup II, we use antenna array with four elements.

Fig. 5(a) illustrates the use of System Setup I. Traditionally, the mobiles are assigned to the base stations with the largest path gains, and the mobile powers are obtained by an iterative fixed assignment power control algorithm as given by (5). In Fig. 6(a), the dash-dot curve shows the total mobile power at each iteration. This algorithm converges in about 16 iterations. In Fig. 5(b), using the same system setup, the base station assignment is done by the jointly optimal base station assignment and power control algorithm, and mobiles have the option to select among the four closest base stations [12]. The total mobile power is depicted in Fig. 6(a). The dashed curves show that the total power is slightly less than that of the first algorithm considered in Fig. 5(a). This algorithm converges in about 15 iterations. In Fig. 5(c), we use the System Setup II, i.e., the base stations are equipped with four-element antenna arrays. We apply our joint power control, base station assignment, and beamforming algorithm to the same configuration of users as in Fig. 5(a) and (b). The solid curve in Fig. 6(a) shows that the total mobile power

is an order of magnitude smaller than that of the previous algorithms. Furthermore, the convergence of this algorithm is much faster; it converges in about five iterations in our simulation study.

The capacity of the system is defined as the maximum number of users for which there exists a feasible power vector. As the number of users grows, the maximum eigenvalue of the gain matrix  $\rho(\mathbf{F}^w)$  approaches unity and the total sum of mobile power is increased. At the same time, the number of iterations needed to achieve the convergence is also increased. In our simulations, we set a maximum value for the number of iterations required for convergence. That is, if the power vector does not converge in 100 iterations, we consider the network as an infeasible system.

Using an antenna array with four elements and our algorithm, we can increase the capacity of the network significantly. In Fig. 6(b), the total mobile power versus the number of users is depicted. Using omnidirectional antennas and the power control algorithm with fixed base assignment, we can tolerate, at most, 660 users. In the same configuration, using the joint base station assignment and power control algorithm proposed in [12], we can increase the capacity to 800 users. If we use antenna arrays with four elements, using our algorithm, the network can tolerate 2800 users. Fig. 7 illustrates the base station assignments for the above three cases. Fig. 6(b) shows that, for a fixed number of users in our system, the total mobile power is an order of magnitude less than that of a power-controlled network with omnidirectional antennas.

TABLE I  
MAXIMUM NUMBER OF USERS

System setup	Maximum number of users
Fixed power	30
Fixed power and beamforming	90
Power control	660
Power control and base assignment	800
Power control and beamforming	2800

Table I shows the maximum number of users for different system settings. In the first row of the table, the maximum capacity of the network for a fixed power allocation and the same target SINR is shown. The capacity of the same network with fixed power allocations and where each base station uses four-element antennas is three times better than that of the fixed power network with omnidirectional antennas. However, it is significantly less than the capacity of a power-controlled network.

It has been observed in [12] that the integration of base station assignment and power control significantly increases the local capacity, i.e., handling more users when we have a hotspot in a network. In order to demonstrate the effectiveness of our proposed approach, in Fig. 8, 400 users are dispersed randomly around the network. We then added users randomly in the local area of  $[3.5, 4.5] \times [3.5, 4.5]$ . When we add 22 users to the System Setup I, the traditional fixed base station assignment reaches its limit. Using the power allocation and base station assignment [12] and the same system setup, when we add 57 users, we get overload. Using System Setup II and our method, we can add 150 users prior to overload.

In summary, when we have the same configuration of users, the use of adaptive antenna arrays in the base stations and our algorithm significantly reduce the mobile power by almost an order of magnitude, which is very critical in terms of battery life in mobile sets. Secondly, it provides faster convergence compared to the existing power control algorithms, and third, it can increase the capacity of systems significantly.

## VII. CONCLUSION

We have introduced the consideration of joint optimal beamforming and power control. We provided an iterative algorithm amenable to distributed implementation which converges to the optimal beamforming and power allocations if there exists at least one solution to the joint problem. An enhancement of the algorithm that makes it appropriate for joint power control and base assignment as well as beamforming was also considered.

For performance evaluation of our algorithm, a notion of capacity was considered to be the maximum number of transmitters for which there exists a feasible power vector. It has been shown that, by using antenna arrays at the base stations, the algorithm will improve the capacity of networks to support a significantly larger number of users. It also speeds up the convergence of the iterative power control algorithm and saves the mobile power.

## REFERENCES

- [1] A. F. Naguib, A. Paulraj, and T. Kailath, "Capacity improvement with base-station antenna arrays in cellular CDMA," *IEEE Trans. Veh.*

- Technol.*, vol. 43, pp. 691–698, Aug. 1994.
- [2] J. M. Aein, "Power balancing in system employing frequency reuse," *COMSAT Tech. Rev.*, vol. 3, no. 2, pp. 272–299, Fall 1973.
- [3] R. W. Nettleton and H. Alavi, "Power control for spread spectrum cellular mobile radio system," in *Proc. IEEE Vehicular Technology Conf. (VTC'83)*, 1983, pp. 242–246.
- [4] J. Zander, "Performance of optimum transmitter power control in cellular radio systems," *IEEE Trans. Veh. Technol.*, vol. 41, pp. 57–62, Feb. 1992.
- [5] S. Grandhi, R. Vijayan, D. J. Goodman, and J. Zander, "Centralized power control for cellular radio systems," *IEEE Trans. Veh. Technol.*, vol. 42, pp. 466–468, Nov. 1993.
- [6] J. Zander, "Distributed cochannel interference control in cellular radio systems," *IEEE Trans. Veh. Technol.*, vol. 41, pp. 305–311, Aug. 1992.
- [7] S. A. Grandhi, R. Vijayan, and D. J. Goodman, "A distributed algorithm for power control in cellular radio systems," in *Proc. 30th Allerton Conf. Communications Control and Computing*, Monticello, IL, Sept. 1992.
- [8] G. J. Foschini, "A simple distributed autonomous power control algorithm and its convergence," *IEEE Trans. Veh. Technol.*, vol. 42, pp. 641–646, Nov. 1993.
- [9] D. Mitra, "An asynchronous distributed algorithm for power control in cellular radio systems," in *Proc. 4th WINLAB Workshop Third Generation Wireless Information Networks*, 1993, pp. 249–259.
- [10] R. Yates and C. Y. Huang, "Integrated power control and base station assignment," *IEEE Trans. Veh. Technol.*, vol. 44, pp. 638–644, Aug. 1995.
- [11] R. Yates, "A framework for uplink power control in cellular radio systems," *IEEE J. Select. Areas Commun.*, vol. 13, pp. 1341–1347, Sept. 1995.
- [12] S. V. Hanly, "An algorithm for combined cell-site selection and power control to maximize cellular spread spectrum capacity," *IEEE J. Select. Areas Commun.*, vol. 13, pp. 1332–1340, Sept. 1995.
- [13] F. R. Gantmacher, *The Theory of Matrices*, vol. 2. New York: Chelsea, 1990.
- [14] B. Suard, A. Naguib, G. Xu, and A. Paulraj, "Performance analysis of CDMA mobile communication systems using antenna array," in *Proc. ICASSP'93*, Minneapolis, MN, Apr. 1993, vol. IV, pp. 153–156.
- [15] R. A. Monzingo and T. W. Miller, *Introduction to Adaptive Arrays*. New York: Wiley, 1980.
- [16] G. Xu, Y. Cho, A. Paulraj, and T. Kailath, "Maximum likelihood detection of co-channel communication signals via exploitation of spatial diversity," in *Proc. 26th Asilomar Conf. Signals, Systems, and Computers*, Pacific Grove, CA, Oct. 1992, vol. 2, pp. 1142–1146.
- [17] B. Ottersten, R. Roy, and T. Kailath, "Signal waveform estimation in sensor array processing," in *Proc. 23rd Asilomar Conf. Signals, Systems, and Computers*, Pacific Grove, CA, Nov. 1989, vol. 2, pp. 787–791.
- [18] J. G. Proakis, *Digital Communications*. New York: McGraw-Hill, 1995.
- [19] F. Rashid-Farrokhi, L. Tassiulas, and K. J. R. Liu, "Joint optimal power control and beamforming for wireless networks with antenna arrays," in *Proc. IEEE Global Telecommunications Conf. (GLOBECOM'96)*, London, U.K., Nov. 1996, pp. 1-555–1-559.
- [20] F. Rashid-Farrokhi, K. J. R. Liu, and L. Tassiulas, "Transmit and receive diversity and equalization in wireless networks with fading channels," presented at GLOBECOM'97, Phoenix, AZ, Nov. 1997, vol. 3, pp. 1193–1198.



Farrokh Rashid-Farrokhi (S'88–M'97) received the B.S. and M.S. degrees (highest honors) from Sharif University of Technology, Tehran, Iran, and the Ph.D. degree from the University of Maryland at College Park in 1988, 1992, and 1997, respectively, all in electrical engineering.

He joined the Wireless Communications Research Department, Bell Laboratories, Lucent Technologies, Holmdel, NJ, as a Member of Technical Staff in 1998. His research interests include array and statistical signal processing, wireless telecommunications, and networking.

Dr. Rashid-Farrokhi received the 1996–1997 George Harhalakis Outstanding Systems Engineering Graduate Student Award in recognition of outstanding contributions in cross-disciplinary research from the University of Maryland at College Park.



Leandros Tassioulas (S'89-M'91) was born in Katerini, Greece, in 1965. He received the Diploma in electrical engineering from the Aristotelian University of Thessaloniki, Thessaloniki, Greece, in 1987 and the M.S. and Ph.D. degrees in electrical engineering from the University of Maryland at College Park in 1989 and 1991, respectively.

From 1991 to 1995, he was an Assistant Professor in the Department of Electrical Engineering, Polytechnic University, Brooklyn, NY. In 1995, he joined the Department of Electrical Engineering, University of Maryland at College Park, where he is currently an Associate Professor. He holds a joint appointment with the Institute for Systems Research and is a member of the Center for Satellite and Hybrid Communication Networks, established by NASA. His research interests are in the field of computer and communication networks, with emphasis on wireless communications (terrestrial and satellite systems) and high-speed network architectures and management, in control and optimization of stochastic systems, and in parallel and distributed processing.

Dr. Tassioulas received a National Science Foundation (NSF) Research Initiation Award in 1992, an NSF Faculty Early Career Development Award in 1995, and an Office of Naval Research Young Investigator Award in 1997. He coauthored the paper which received the Best Paper Award at INFOCOM'94.



K. J. Ray Liu (S'86-M'86-SM'93) received the B.S. degree from National Taiwan University, Taipei, Taiwan, R.O.C., in 1983 and the Ph.D. degree from the University of California, Los Angeles, in 1990, both in electrical engineering.

Since 1990, he has been with the Electrical Engineering Department and Institute for Systems Research, University of Maryland, College Park, where he is an Associate Professor. During his sabbatical leave from 1996 to 1997, he was a Visiting Associate Professor at Stanford University,

Stanford, CA. His research interests span various aspects of signal/image processing and communications. He has published more than 130 papers, of which more than 50 are in archival journals and book chapters. His research web page is at <http://dsperv.eng.umd.edu>. He is the Book Series Editor of the Marcel Dekker series on signal processing and Co-Editor of *High Performance VLSI Signal Processing, Volume I: System Design and Methodology* and *High Performance VLSI Signal Processing, Volume II: Algorithms, Architectures, and Applications* (Piscataway, NJ: IEEE Press, 1998). He is also the Editor of the *Journal of VLSI Signal Processing*.

Dr. Liu has received numerous awards, including the 1994 National Science Foundation Young Investigator Award, the 1993 Senior Award (Best Paper Award) from the IEEE Signal Processing Society, the George Corcoran Award in 1994 for outstanding contributions to electrical engineering education and the 1995-1996 Outstanding Systems Engineering Faculty Award in recognition of outstanding contributions in interdisciplinary research, both from the University of Maryland. He has been an Associate Editor of the IEEE TRANSACTIONS ON SIGNAL PROCESSING. He is a Guest Editor of Special Issues on Multimedia Signal Processing for Wireless Communications of the IEEE JOURNAL ON SELECTED AREAS IN COMMUNICATIONS and a founding member of the Multimedia Signal Processing Technical Committee of the IEEE Signal Processing Society.