

Induced Current Effects Produced in Heart Pacemaker Patients by Low Frequency Magnetic Field Security Systems

Adebo Ifesanya, Jon Casamento*, Isaac Chang*, H. Bassen* and Christopher C. Davis

Department of Electrical and Computer Engineering

*FDA Center for Devices and Radiological Health

ABSTRACT

The voltage induced in an implanted pacing system in the presence of an alternating magnetic field produced by a security system was measured and studied. The voltage was determined across the conductive tissue between the case and tip electrodes of the pacing system for varying series load resistance and medium conduction path. A computer simulation was used to model the current density and resistive effect between the electrodes. A mathematical expression was also derived from modeling the system as an electrical network and compared with our experimental results. With these results induced current effects can be determined.

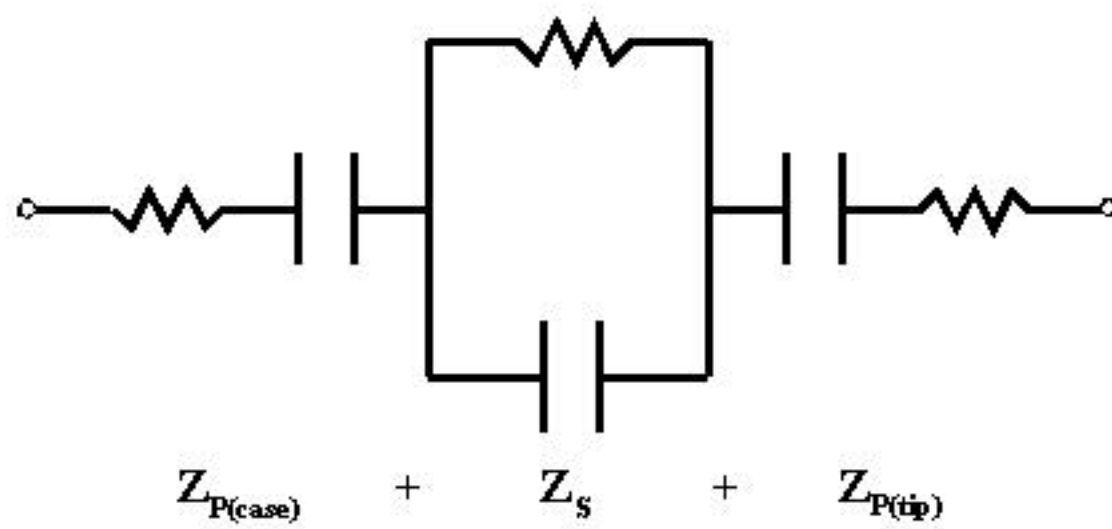
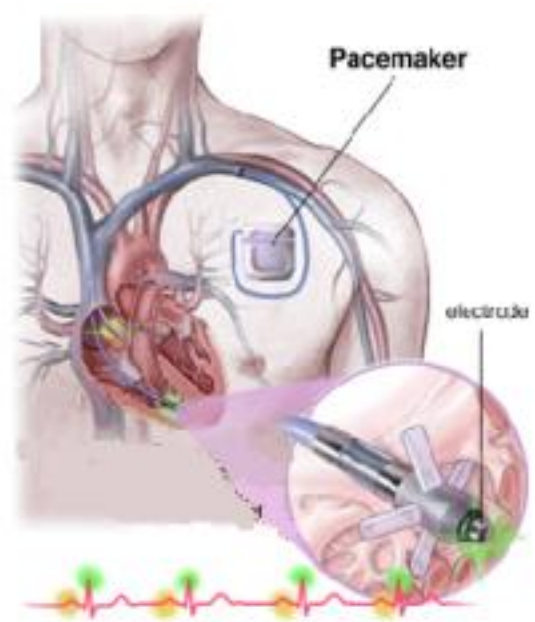

INTRODUCTION

When a patient with an implanted medical device is exposed to an alternating magnetic field from an electronic article surveillance (EAS) system, there is a potential risk of malfunction or damage to the device. These devices such as a pacemaker are mostly implanted in some type of loop shape.

According to Faraday's law of induction, voltage is induced into a conducting closed loop by a changing magnetic flux.

$$\hat{V}_{ind} = -j\omega BA_{loop}$$

Human tissue contains electrolytes and is conductive, hence there is a current pathway between electrodes. The impedance developed between the electrodes is a series combination of the tissue impedance (in our case, saline), Z_s , and the electrode polarization impedance Z_p .

METHODS AND MATERIALS

- A phantom containing physiological saline was prepared as an approximate equivalent of the electrical properties of tissue.
- The combined impedance was measured with an Impedance Analyzer from 10Hz to 1MHz, keeping other dependent parameter constant.
- The magnetic field source was a "Knogo" EAS system producing a 219Hz continuous wave.
- The block diagram of the experimental setup is shown below

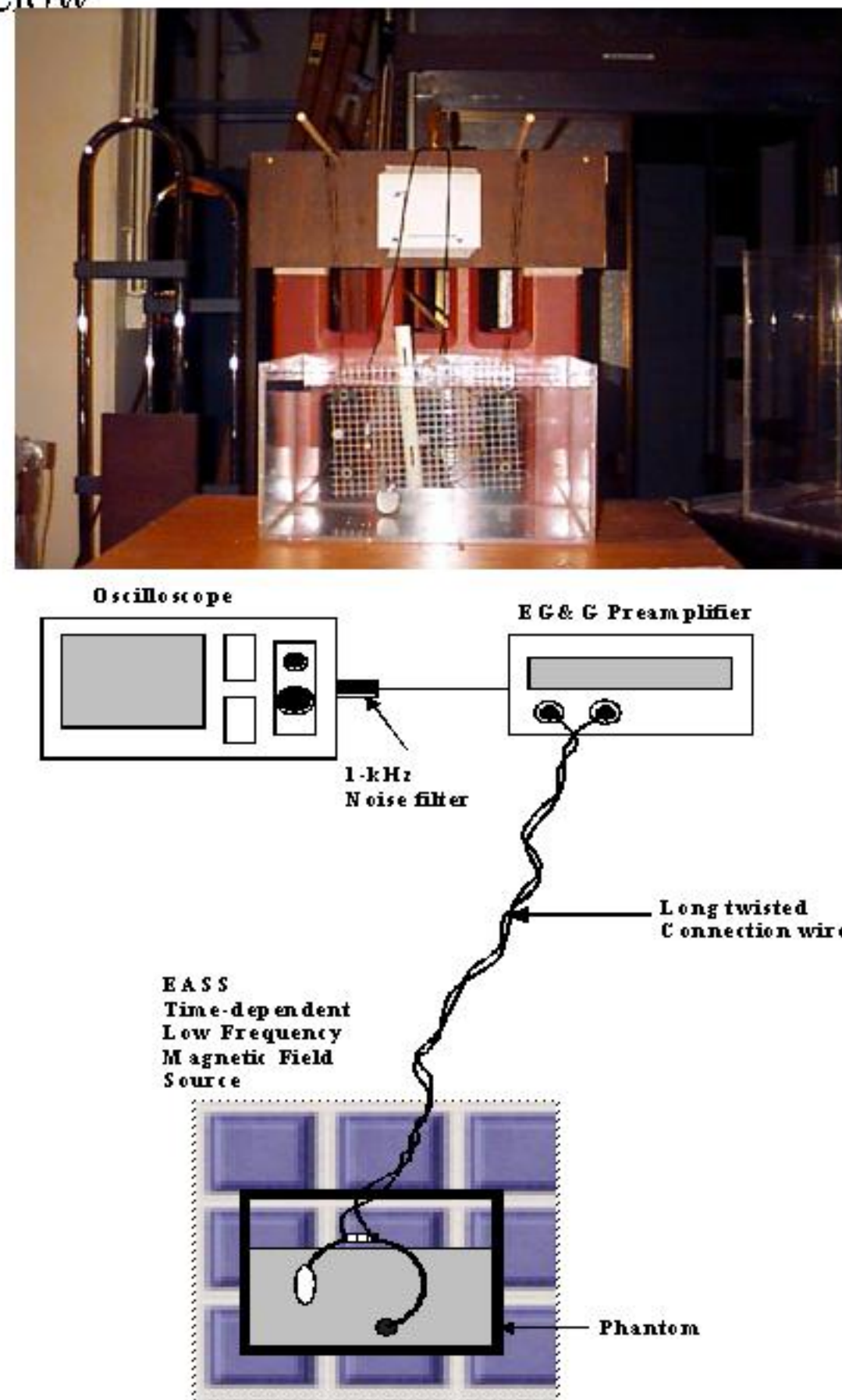

RESULTS

- The peak value of the maximum flux through the loop was measured to be $550\mu T$.
- The experimental data and the formulated V_{meas} are comparable.
- The V_{meas} changes with the variation of saline in the phantom.
- The derived V_{meas} was expressed as

$$V_{meas} = \frac{V_{ind}}{Z_T} \left(\frac{Z_T R_{series}}{Z_T + R_{series}} \right)$$

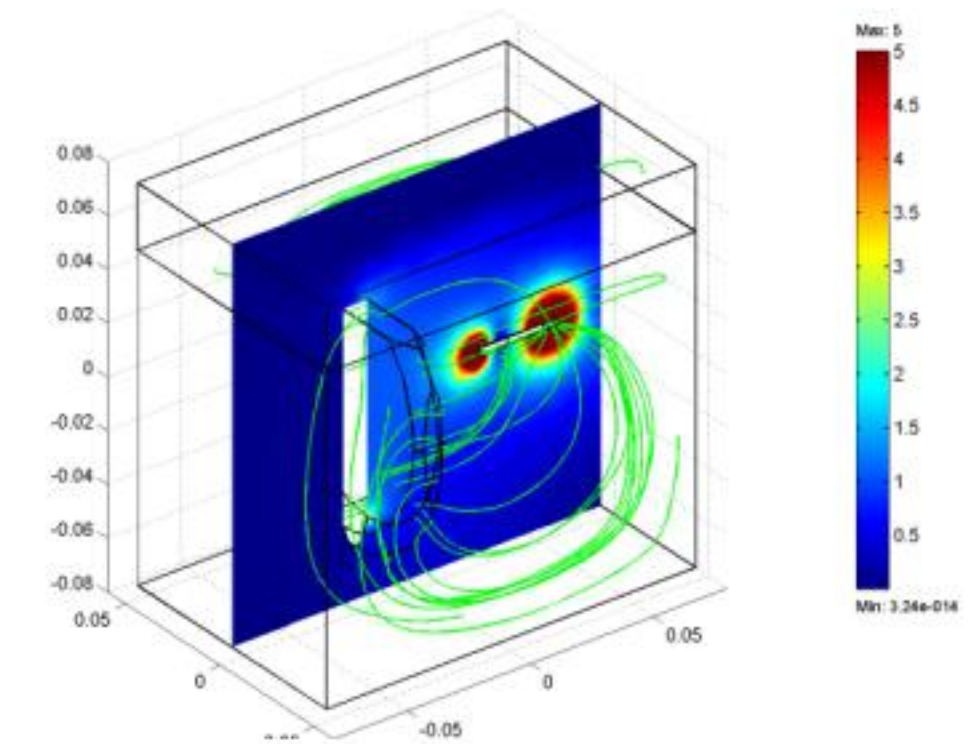
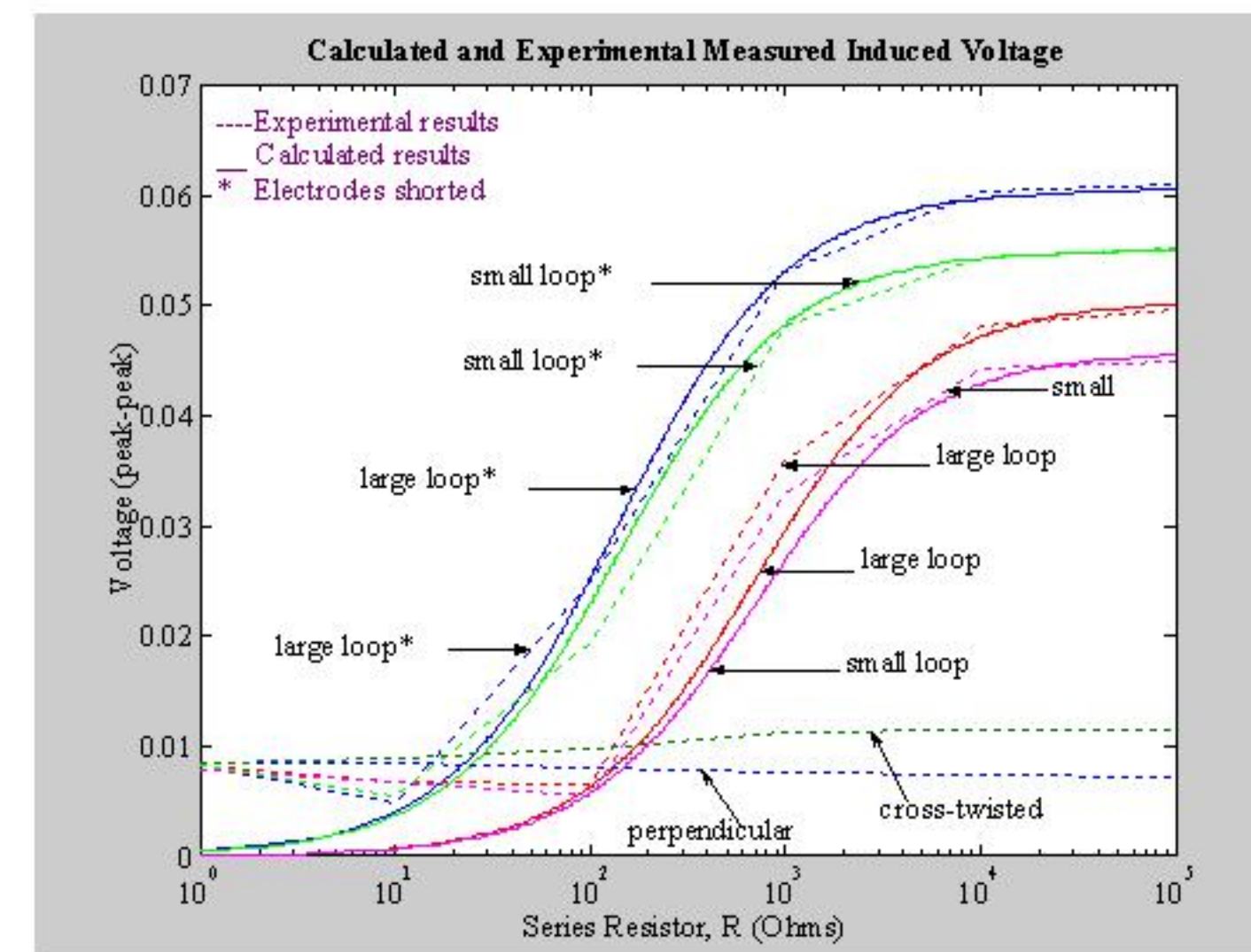
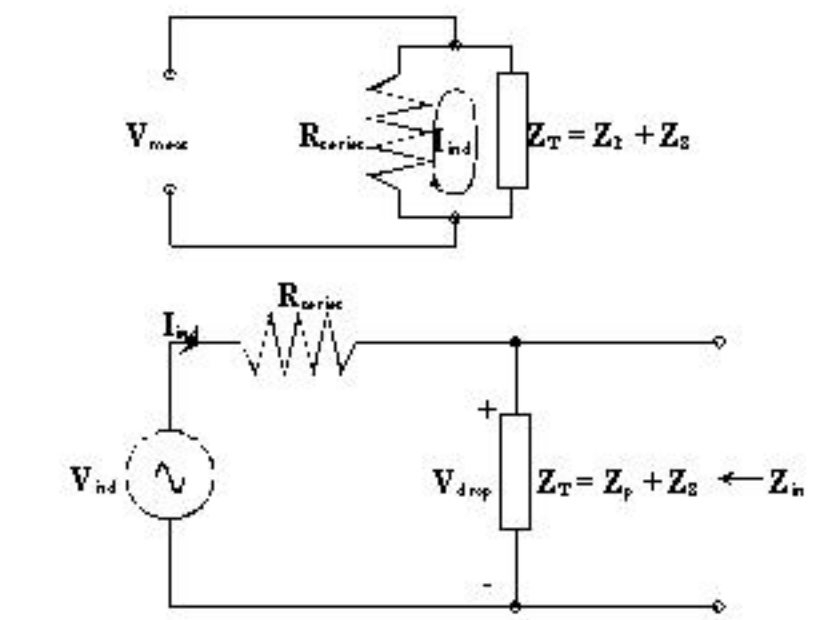
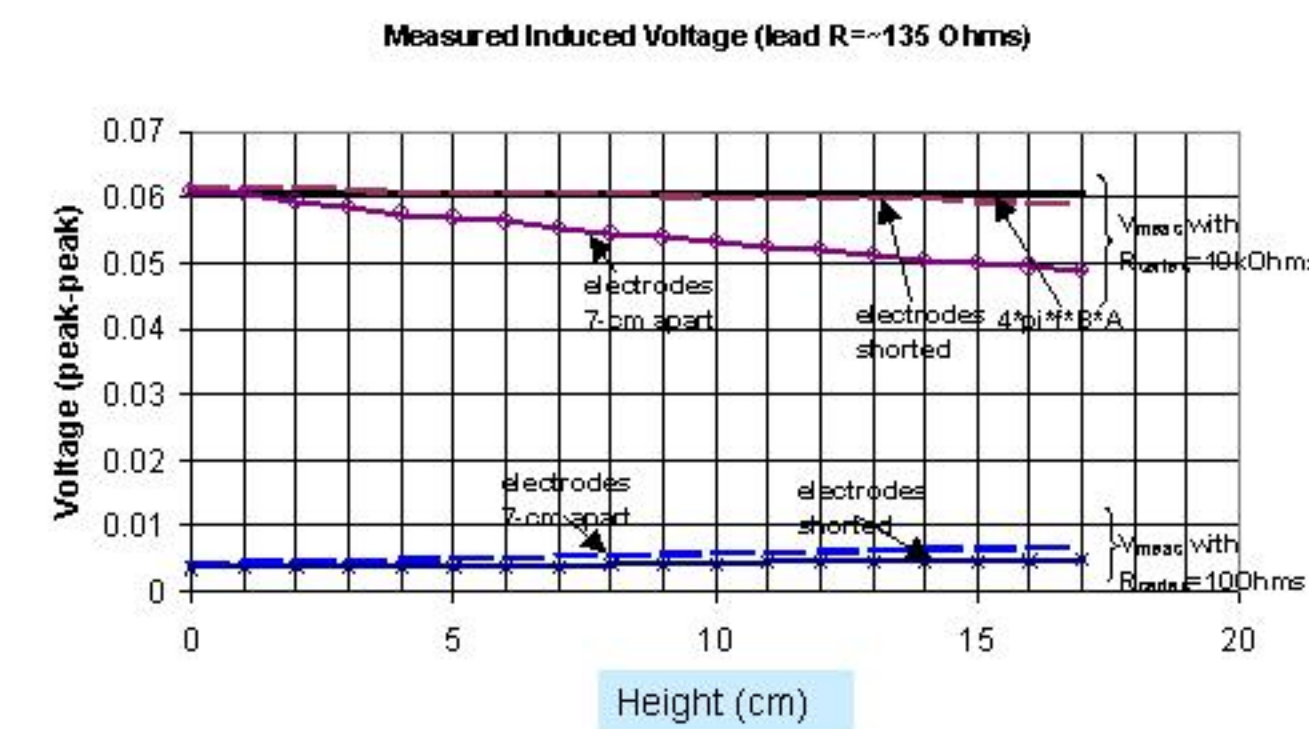

Simulation of current and electric field from FEMLAB

CONCLUSION

- The impedance created between the electrodes decreases as the "volume" of the medium increases, $R = \int_C E_y \partial y / \int_S J \partial x \partial z$.
- The current flowing between the electrodes increases slightly as the "volume" of the medium increases also, i.e. $I = JA_{cross-section}$.
- The impedance $|Z_T|$ decreases more rapidly than the current I increases while the height ("volume") of conducting medium in the phantom increases.
- All experimental results showed that maximum V_{meas} does not exceed calculated V_{ind} . Hence, there is no type of voltage interaction involving any algebraic summation of voltage V_{ind} in loop and V_{ind} in medium.