

Sensitivity Analysis for the Integrated Safety Assessment Model (ISAM)

John Shortle

George Mason University

May 28, 2015



Acknowledgments

- Sherry Borener, FAA
- Alan Durston, Brian Hjelle, Saab Sensis
- Seungwon Noh, Zhenming Wang, GMU

Integrated Safety Assessment Model

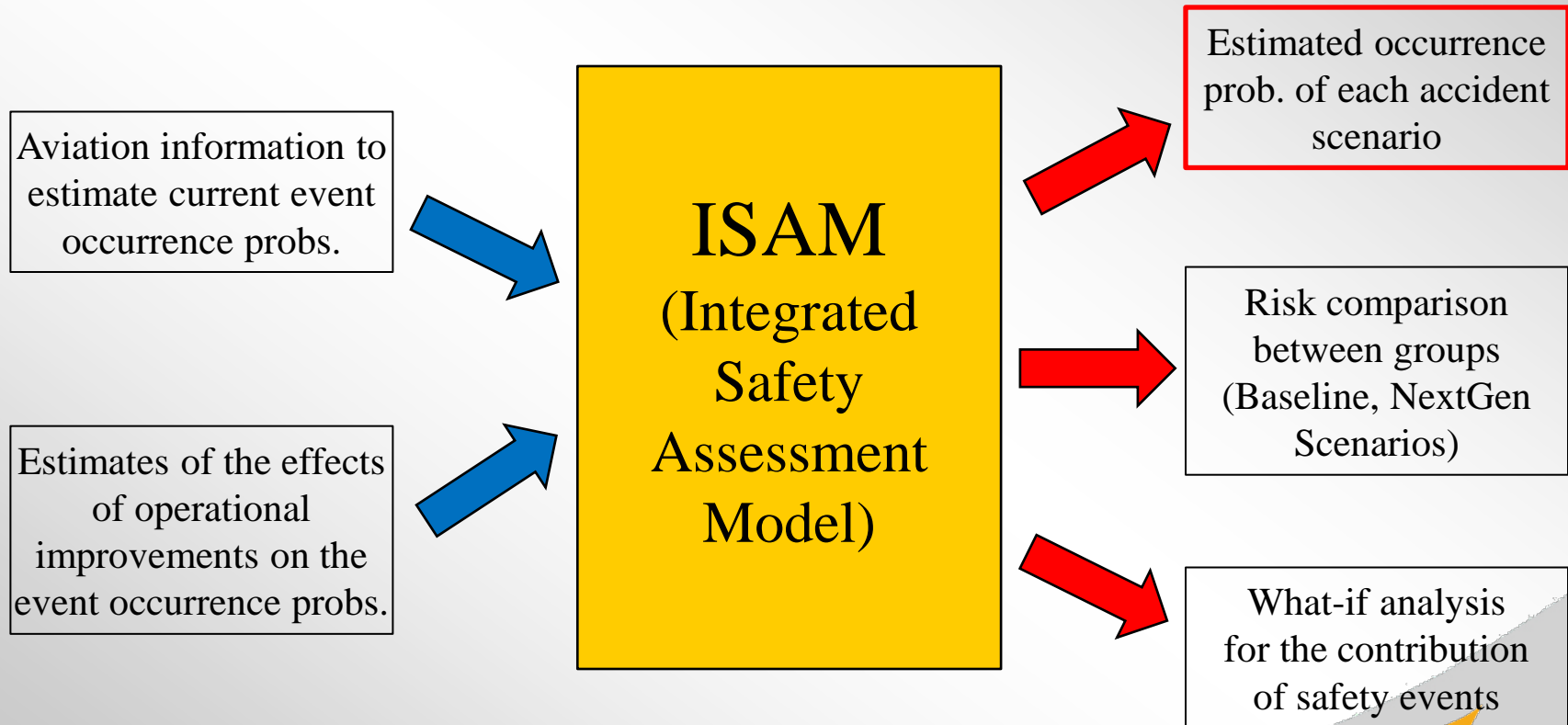

Event Sequence Diagrams (ESD)

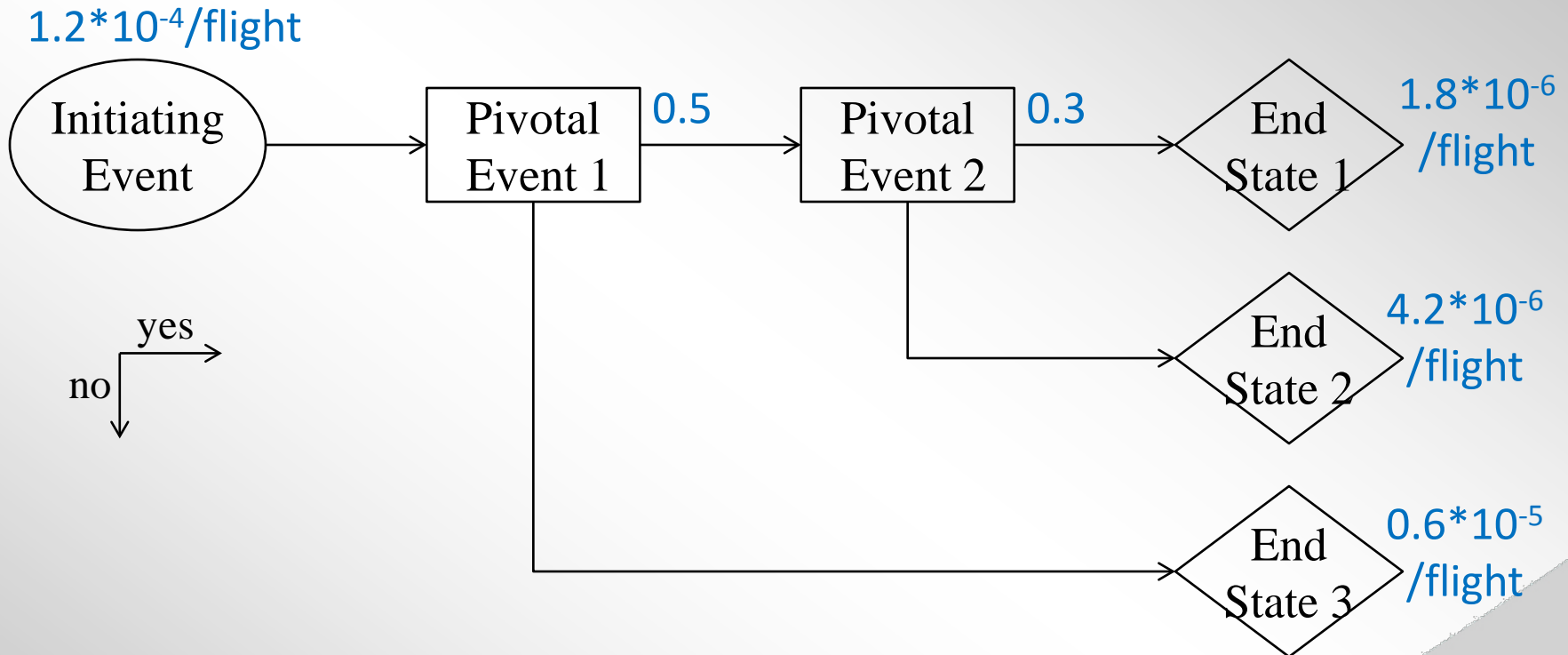

- 35 ESDs capture all aircraft accident scenarios
- Each ESD has a unique initiating event.
- Categorized by flight phase

Example ESD & Fault Trees

ESD US-01: Aircraft system failure during take-off

Data Dictionary

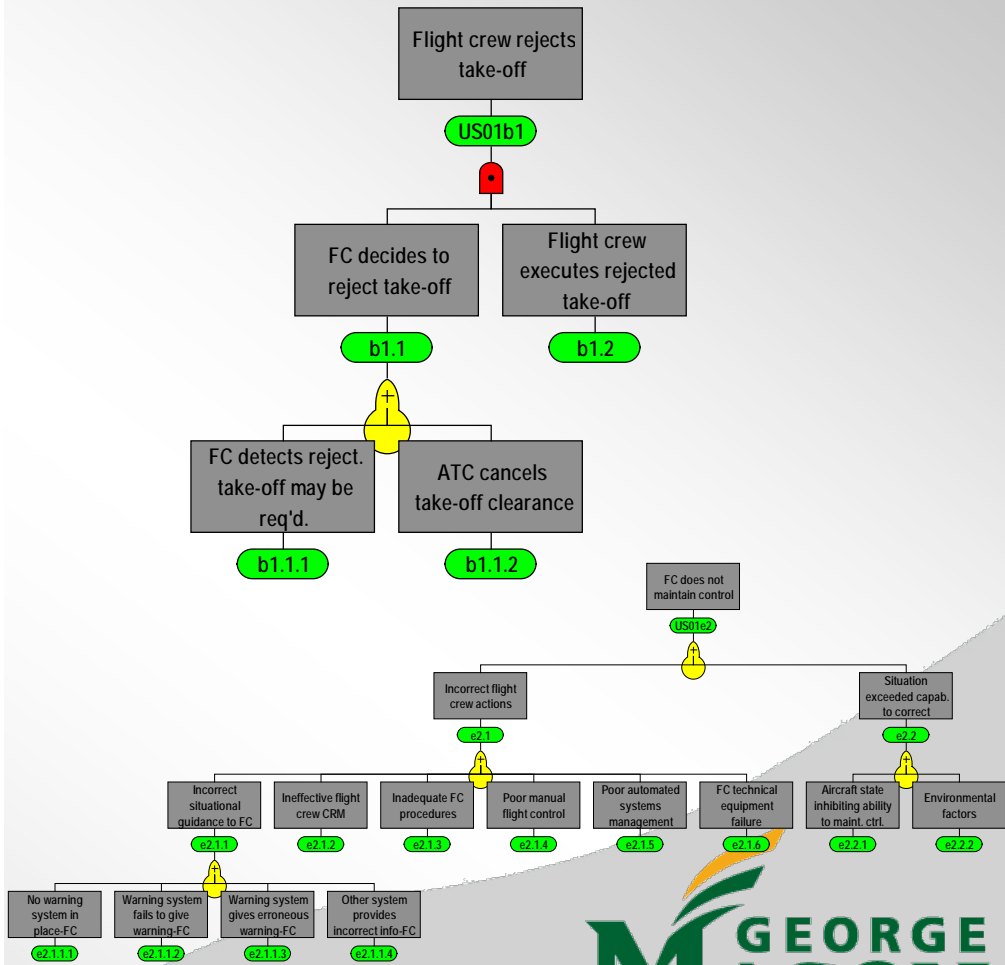
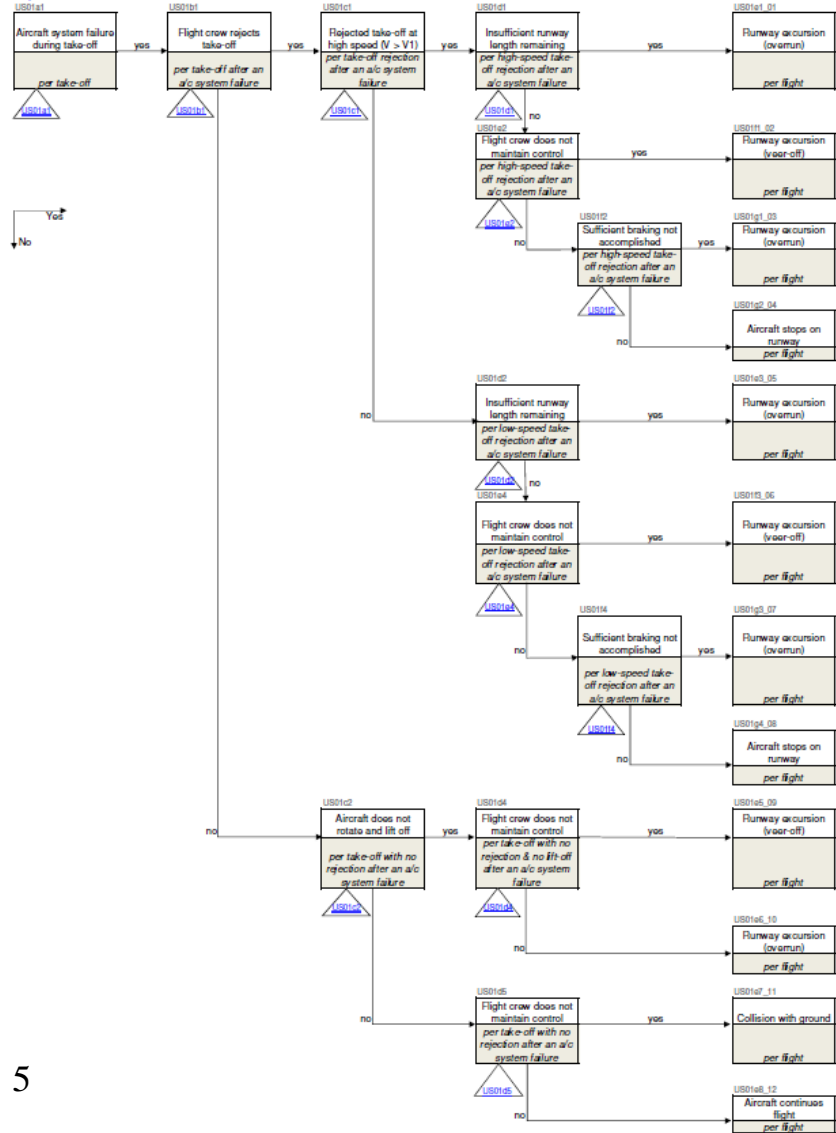

Objective

- ISAM contains thousands of parameters
 - 35 event trees
 - 205 pivoting events
 - 3,454 fault tree nodes
- Objective: Identify most important parameters within ISAM

Quantification of Parameters

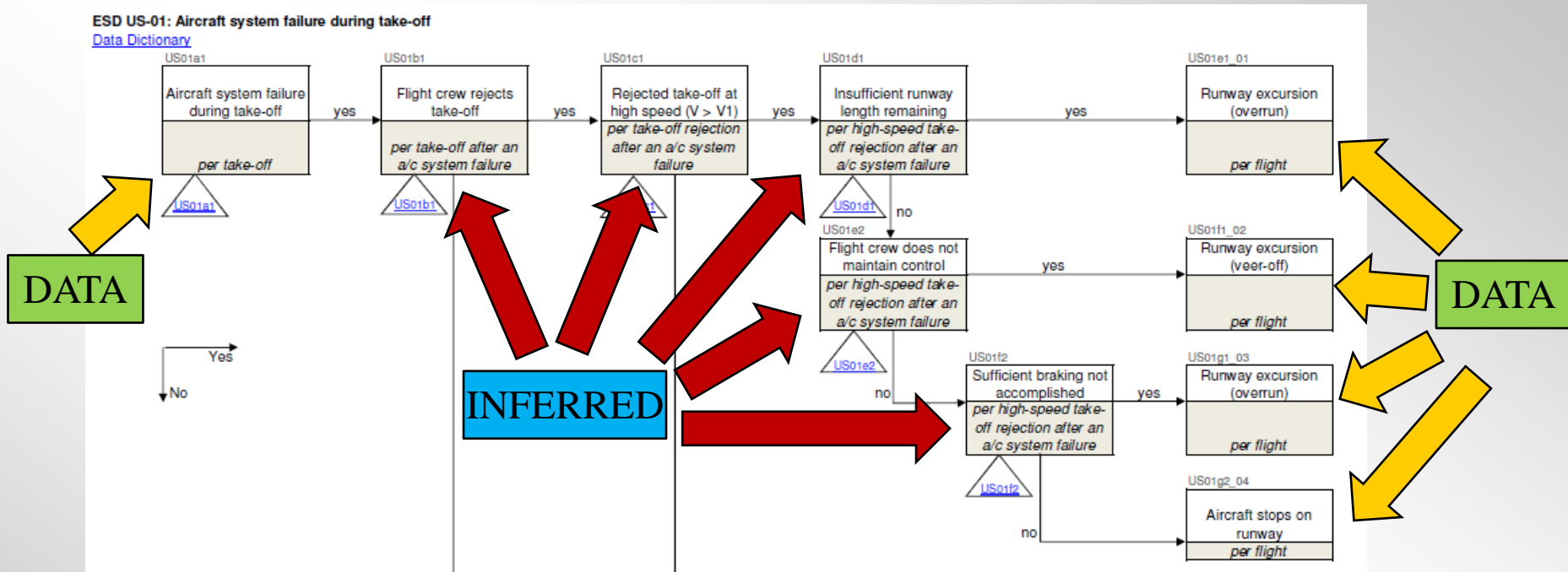

- Probabilities of initiating event and end states are from historical data.
- By solving a system of equations probabilities of pivotal events are inferred.

Sample ESD (US-01)

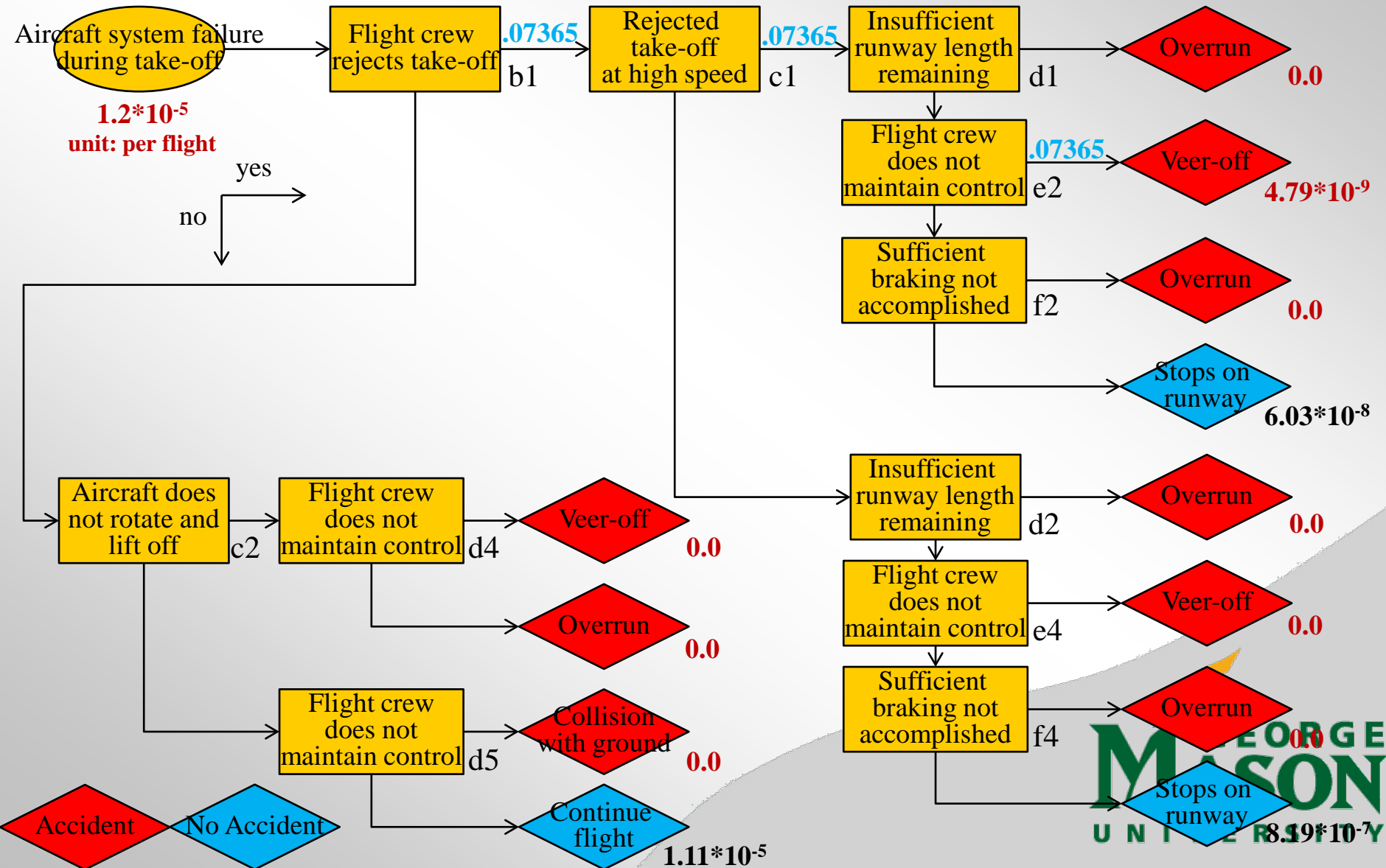

Common Importance Measures

Measure	Principle
Fussell-Vesely (FV)	$\frac{P(base) - P(e_i = 0)}{P(base)}$
Risk Achievement Worth(RAW)	$\frac{P(e_i = 1)}{P(base)}$
Birnbaum Importance (BI)	$P(e_i = 1) - P(e_i = 0)$

- e_i : event i
- $P(e_i = 0 \text{ or } 1)$: probability of accident in which the probability of event i is 0 or 1
- $P(base)$: the baseline probability of an accident

Initial Sample Result (RAW & BI)

- Very similar ranks between RAW / BI importance measures
- Most important
 - Rotating and lifting after no take-off rejection (c2)
 - Maintaining control after lifting off (d5)
- Least important
 - Maintaining an aircraft under control after failure of lifting off (d4)

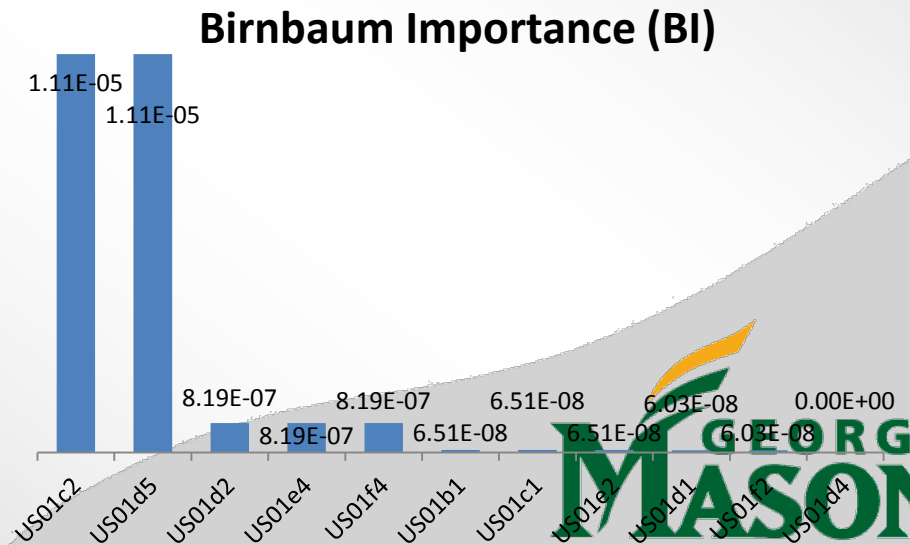
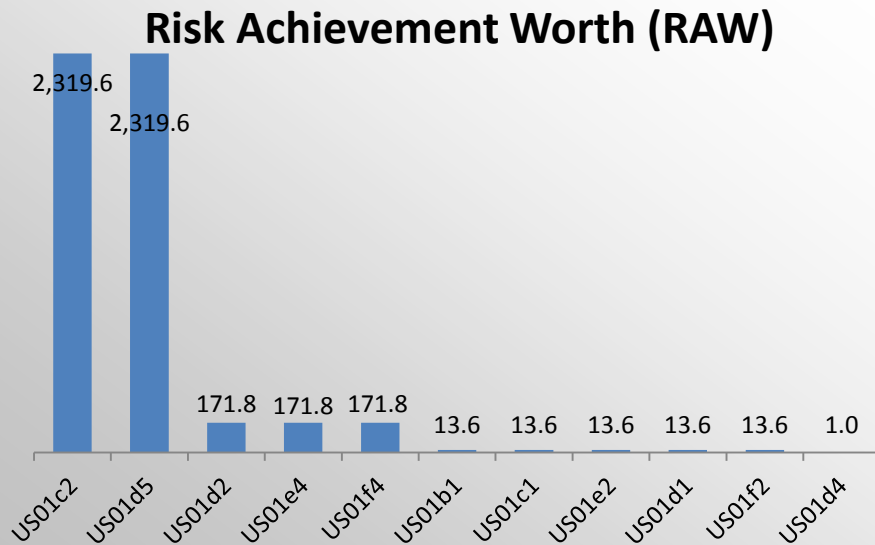

Factorial Design

- Sensitivity results sensitive to baseline values
- Many pivotal events have zero probability
 - Small data, rare-event issue
- Factorial design varies all parameters (2^n combinations)

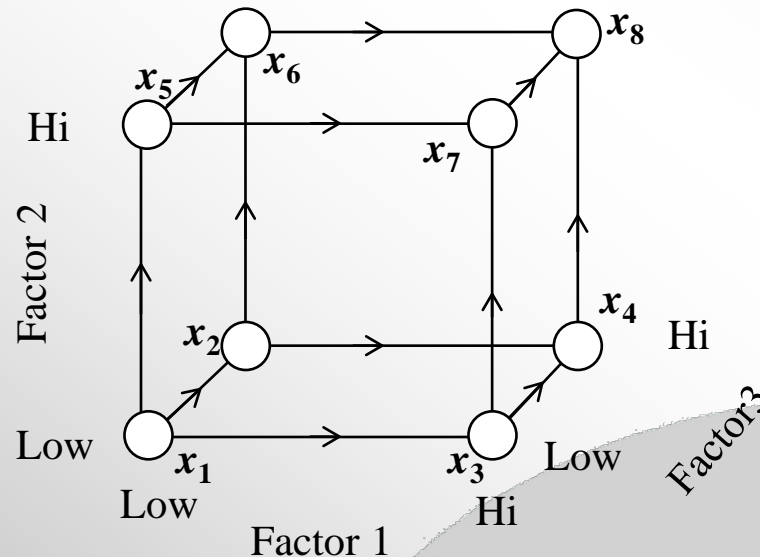

Factorial Design (US-01)

Pivotal Event Unique ID	Low Prob.	High Prob.	Description
US01b1	0	1	flight crew rejects take-off given system failure
US01c1	0	1	rejected take-off at high speed
US01d1	0	1	insufficient runway length remaining in case of high-speed take-off rejection
US01e2	0	1	flight crew does not maintain control in case of high-speed take-off rejection
US01f2	0	1	sufficient braking is not accomplished in case of high-speed take-off rejection
US01d2	0	1	insufficient runway length remaining in case of low-speed take-off rejection
US01e4	0	1	flight crew does not maintain control in case of low-speed take-off rejection
US01f4	0	1	sufficient braking is not accomplished in case of low-speed take-off rejection
US01c2	0	1	aircraft does not rotate and lift off
US01d4	0	1	flight crew does not maintain control in case of no rejection and no lift-off given system failure
US01d5	0	1	flight crew does not maintain control after lift-off

Summary of Rankings (US-01)

Unique ID	RAW	BI	Factorial (0-1)	Factorial (other)
US01b1	6	6	3	7
US01c1	6	6	10	4
US01d1	6	9	4	8
US01e2	6	6	4	9
US01f2	6	9	4	9
US01d2	3	3	4	1
US01e4	3	3	4	2
US01f4	3	3	4	2
US01c2	1	1	1	5
US01d4	11	11	10	11
US01d5	1	1	1	5

■ Important

- Capability of rotating and lifting off after no take-off rejection (c2)
- Maintaining control after lifting off (d5)

■ Not important

- Maintaining control after failure of lifting off (d4)

■ Mixed results

- Whether a take-off rejection is at high speed (c1)
- Insufficient runway length remaining in case of high-speed take-off rejection (d1)
- Sufficient braking is not accomplished in case of high-speed take-off rejection (f2)

Observations

- Similar ranks of pivotal events from RAW, BI importance measures and (0,1) factorial design
- ESDs with the same structure have similar results.
- Main caveat: Results of sensitivity analysis may change with different baseline event probabilities in all methods.

Common Structure: Approach

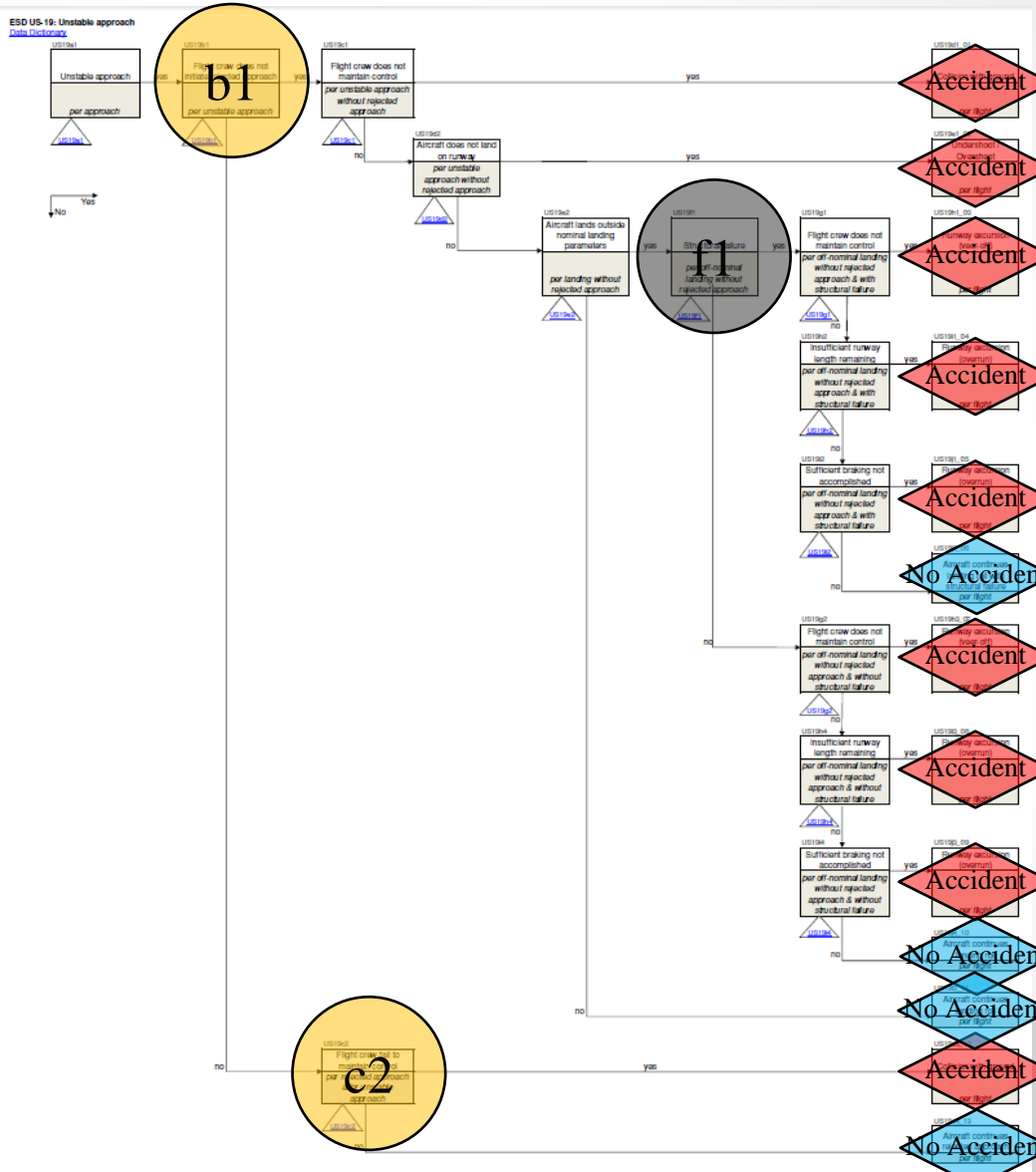

- US-19, US-21, US-23, US-25, US-40
- Most Significant: Initiating rejected approach (b1), failure to maintain control after rejected approach (c2)
- Least Significant: Structural failure after off-nominal landing (f1)

Common Structure: Take-off

ESD US-01: Aircraft system failure during take-off
Data Dictionary

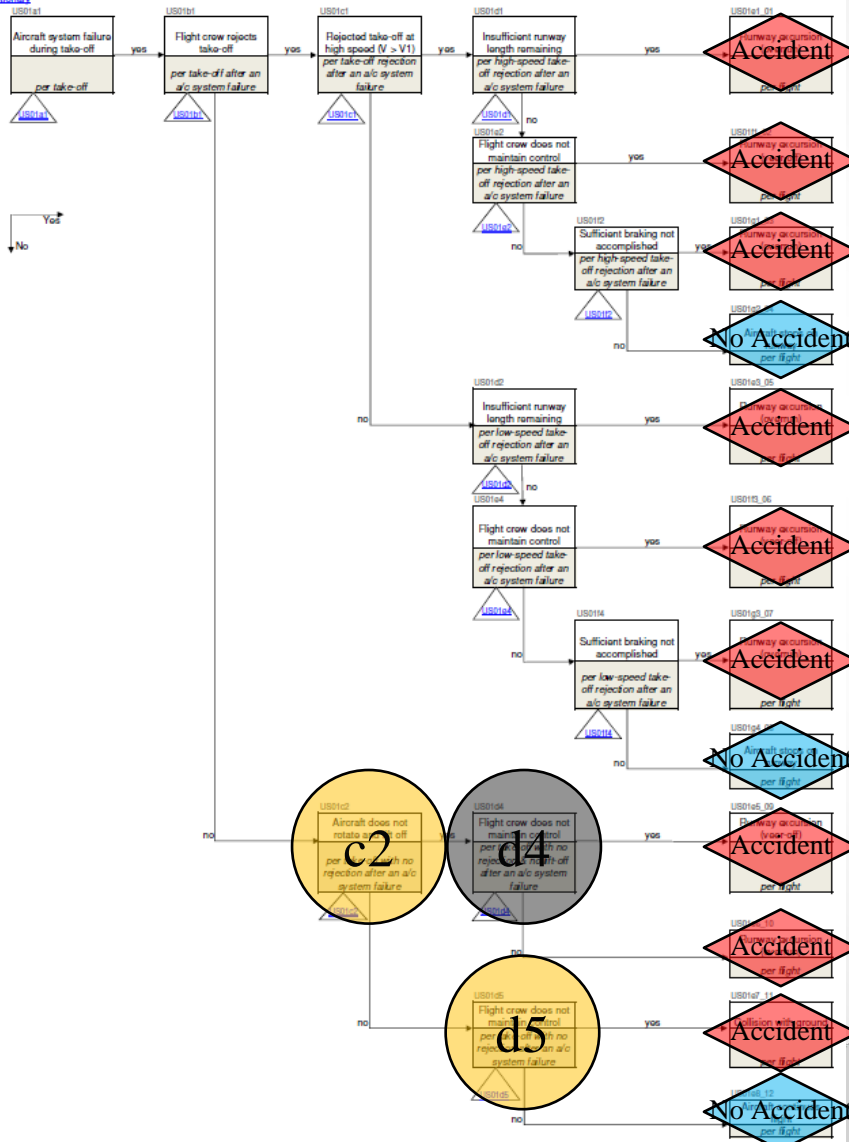

- US-01, US-02, US-03, US-04, US-05, US-09, US-10
- One of a few structures for take-off phase ESDs
- Most Significant: Capability of rotating and lifting off after no take-off rejection (c2) and maintaining control after lifting off (d5)
- Least Significant: Maintaining control after failure of lifting off (d4)

Consequence Data

- Sensitivity with respect to accidents (overrun, veer off, collision with ground, etc.) does not differentiate accident severity
- Repeat analysis where end events are fatalities

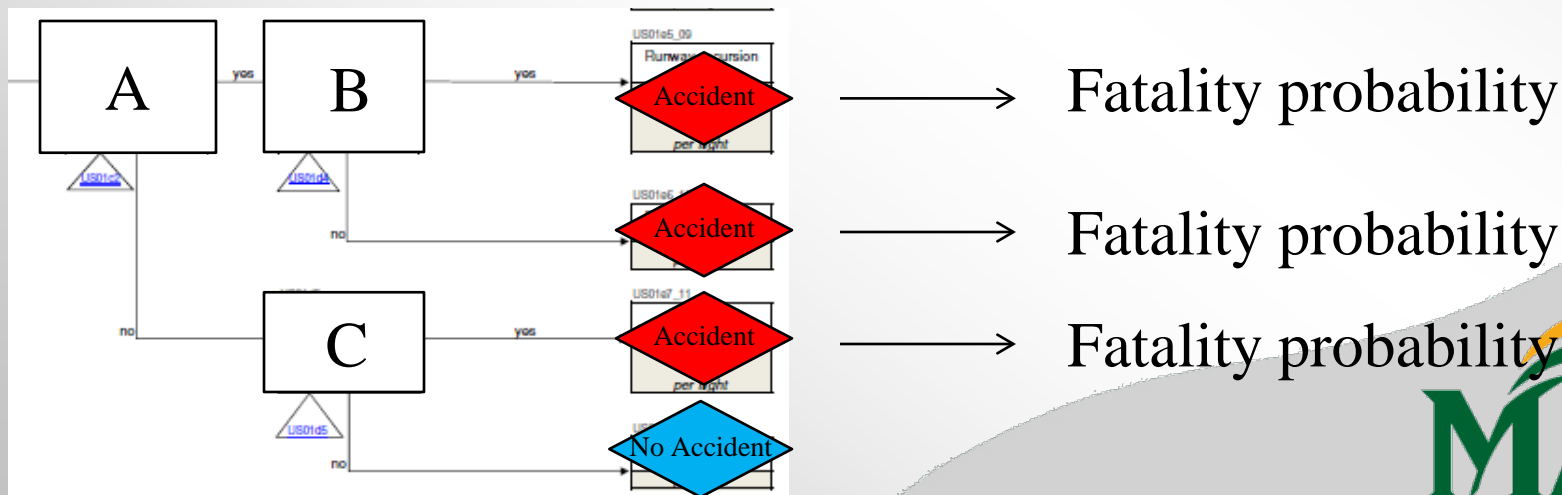

Sensitivity Result w/ Fatality Data

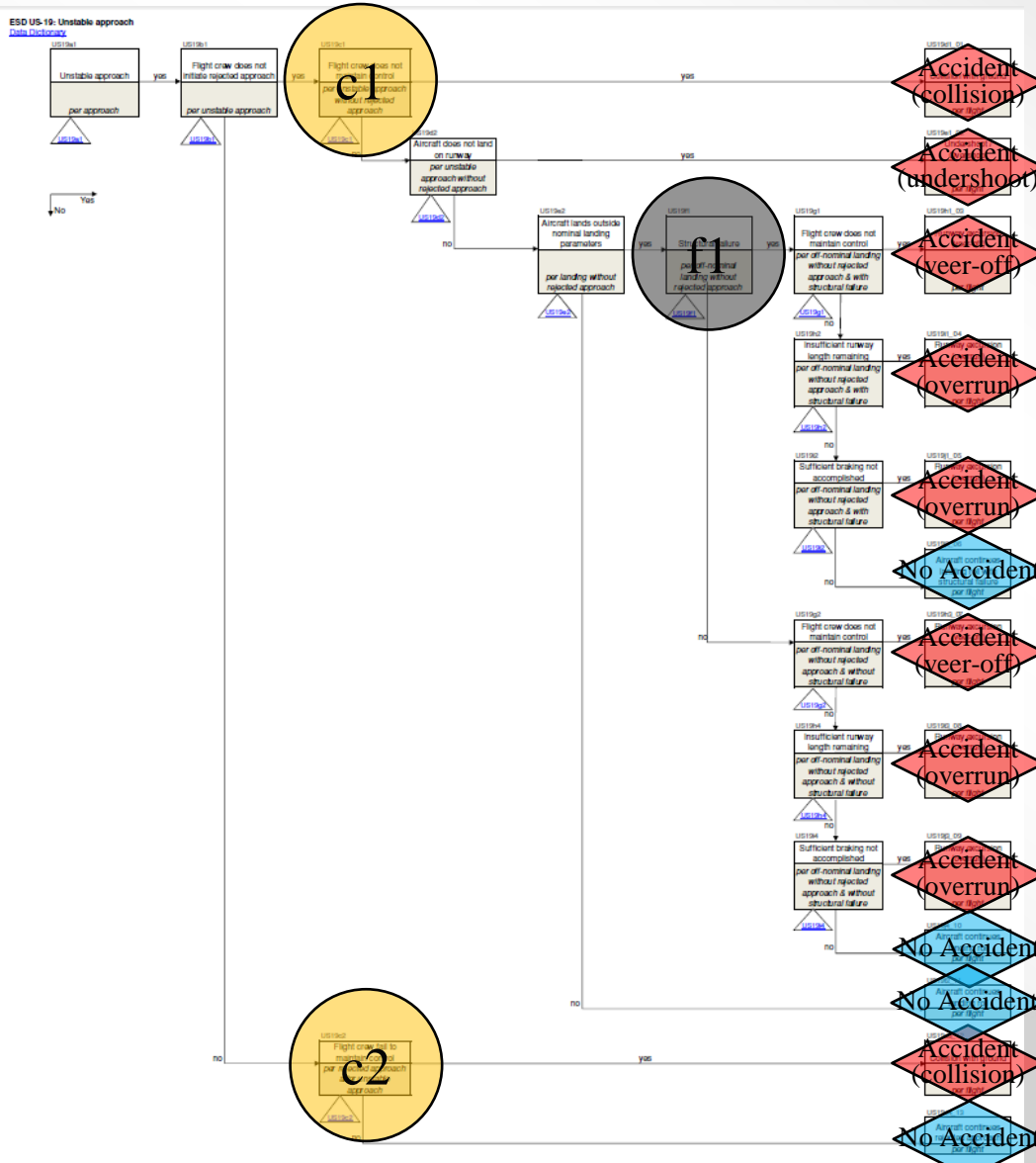

- US-19, US-21, US-23, US-25, US-40 (approach & landing)
- Most Significant: Failure to maintain control without rejected approach (c1) with rejected approach (c2)
- Least significant: Structural failure (f1) from factorial design

Sensitivity Result w/ Fatality Data

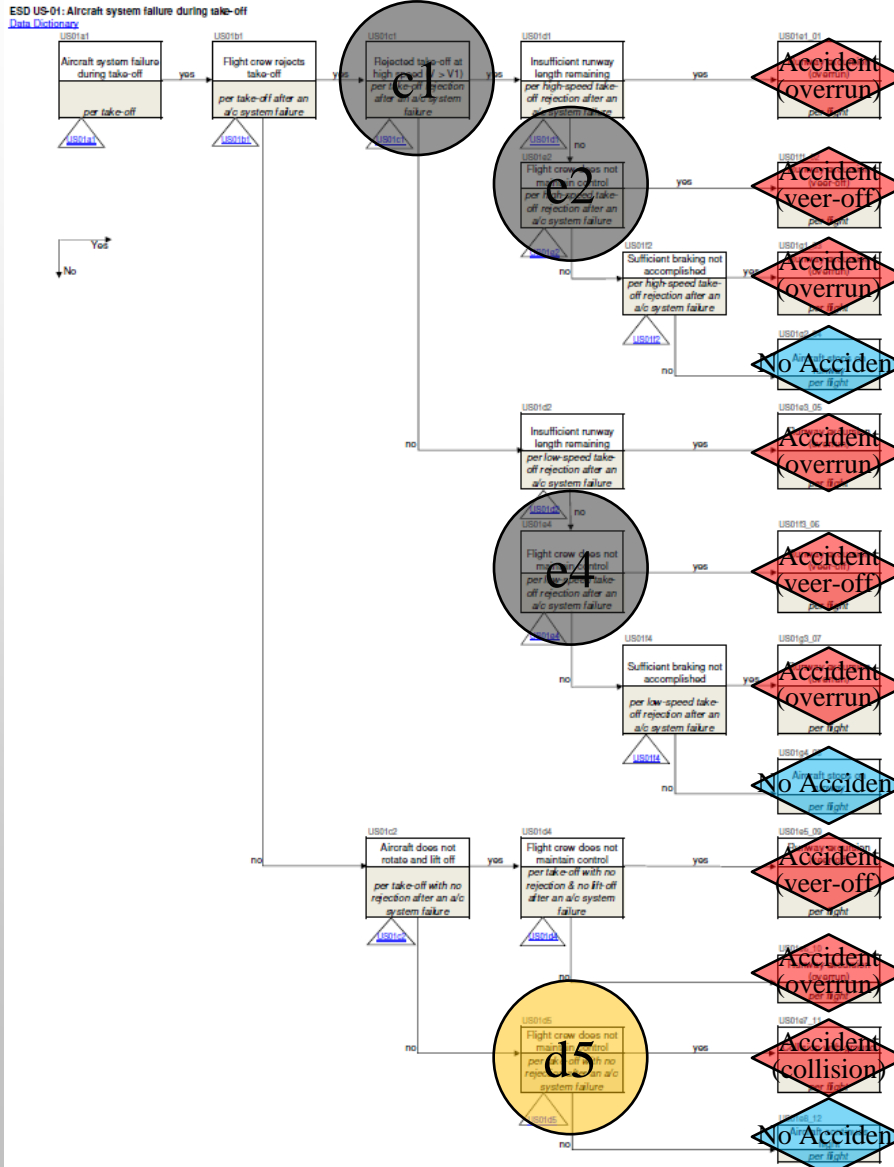

- US-01, US-02, US-03, US-04, US-05, US-09, US-10
- One of a few structures for take-off phase ESDs
- Most Significant: Maintaining control after lifting off (d5)
- Least Significant: Rejected take-off at high speed (c1), maintaining control after high-speed take-off rejection (e2), maintaining control after low-speed take-off rejection (e4) from IMs

Observations

- Some similarities and differences between fatality-based results and accident-based results
- Results within an ESD structure class are not as consistent as before
- Pivotal events located before the end event having zero fatality probability (e.g., veer-off) become less significant.
- More pivotal events with negative importance measure using fatality-based results

Common Events

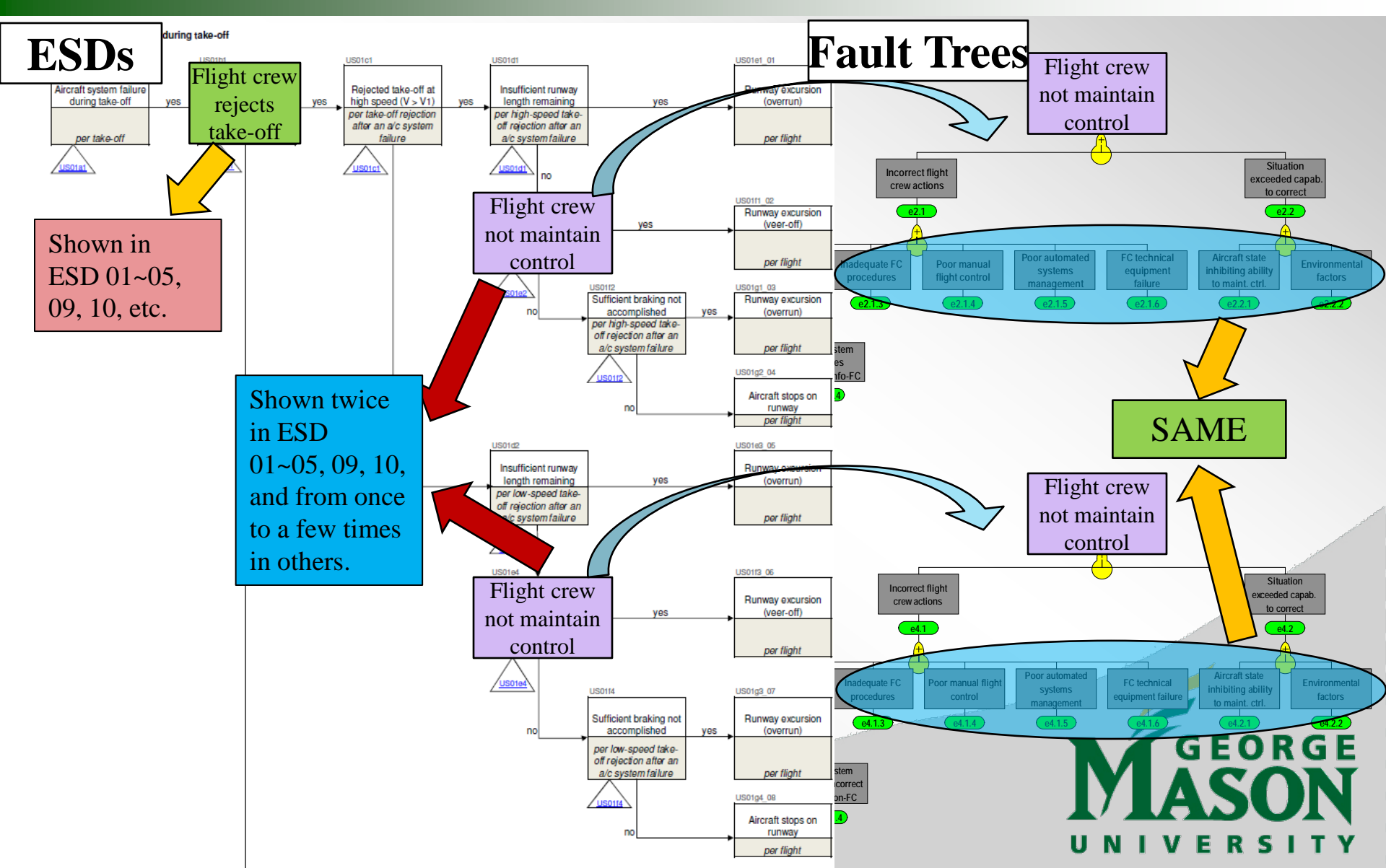

ESDs

Fault Trees

Flight crew rejects take-off

Flight crew not maintain control

Flight crew not maintain control

Flight crew not maintain control

Shown twice in ESD 01~05, 09, 10, and from once to a few times in others.

SAME

Shown in ESD 01~05, 09, 10, etc.

Common Events

- Many events are common to multiple ESDs
- An event that appears in many ESDs may have a higher importance system-wide compared with its importance within one ESD

Net Fatality Probabilities

Expected fatalities per operation

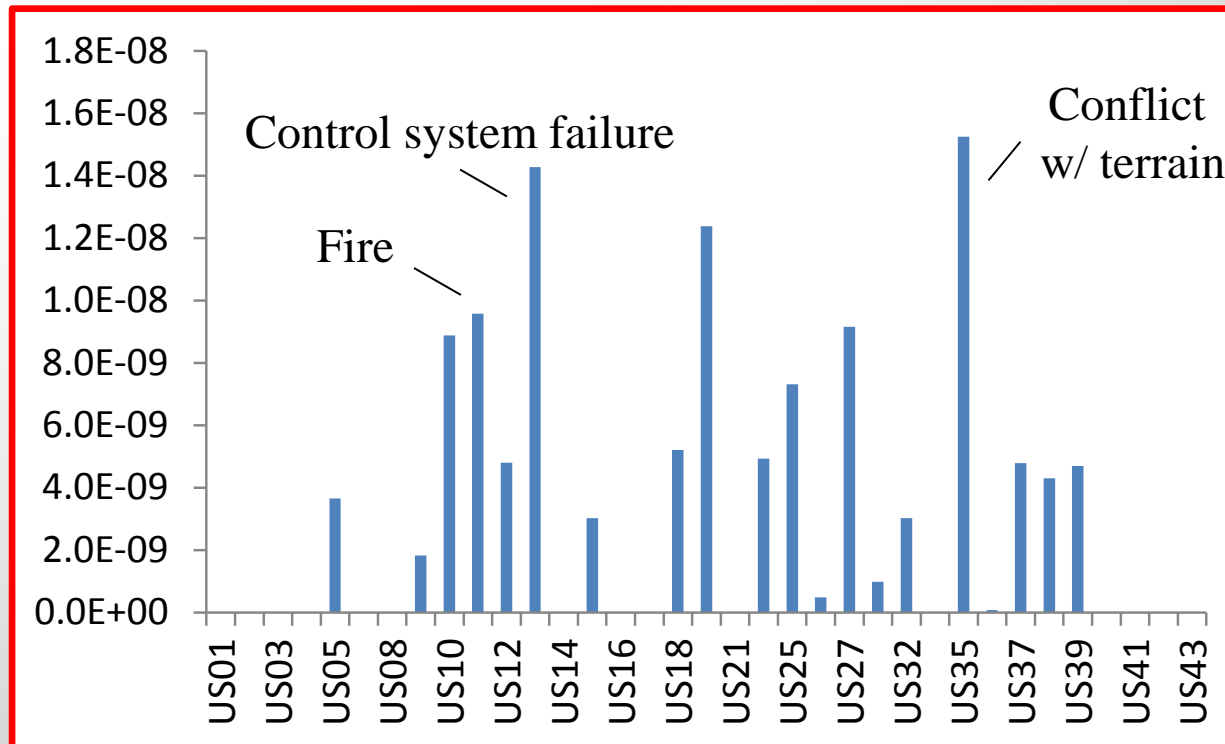

Global metric of interest: Total fatality probability = sum of these values

Top 10 Pivoting Events (Fatality)

- ‘Flight crew does not initiate rejected approach’ is most significant event
 - Decreases fatality frequency by 0.525% when the probabilities of the event increase by 1%.
- Similar top 10 list for accidents

Metric = fatality frequency (red = in both lists)

Pivotal Events	% change of fatality frequency	# of observations
Flight crew does not initiate rejected approach	-0.525%	4
Flight crew does not maintain control	0.498%	75
Sufficient braking not accomplished	0.174%	32
ATC does not resolve the conflict	0.163%	4
Aircraft lands outside nominal landing parameters	0.130%	5
Flight crew does not execute avoidance maneuver successfully	0.129%	1
Insufficient runway length remaining	0.082%	27
Flight crew does not detect and extinguish fire	0.081%	1
Structural failure	-0.055%	5
Flight crew does not execute wind shear escape maneuver	0.042%	1

Caveats

- ISAM model is “truth”
- Uncertainty in data (rare events)
- Results depend on baseline parameters. Mitigate in part by considering:
 - Multiple importance measures
 - Multiple output metrics (accident risk, fatality risk)
 - System-wide analysis and individual ESD analysis
- Common label events treated as identical

Conclusions

- An event may be important for a variety of reasons
- Relationship between # of observations and sensitivity are not clearly detected
- Many common events identified in single ESD and full ISAM analysis
 - ‘ATC does not resolve the conflict’, ‘Flight crew does not maintain control’, ‘Sufficient braking not accomplished’, ‘Insufficient runway length remaining’, etc.
- For pivotal events, top 10 list is similar using accident and fatality metrics, different for fault-tree events
- Results useful as input for further data collection / analysis

Questions

Factorial Design Result (US-01)

Unique ID	Pivotal Probability		Avg. Accident Frequency		Difference (D) – (C)	Sensitivity $\frac{\{(D) - (C)\}}{\{(B)-(A)\}}$
	Low (A)	High (B)	With Low (C)	With High (D)		
US01b1	0	1	4E-06	3.43E-06	5.71E-07	5.71E-07
US01c1	0	1	3.71E-06	3.71E-06	0.00E+00	0.00E+00
US01d1	0	1	3.86E-06	3.57E-06	2.86E-07	2.86E-07
US01e2	0	1	3.86E-06	3.57E-06	2.86E-07	2.86E-07
US01f2	0	1	3.86E-06	3.57E-06	2.86E-07	2.86E-07
US01d2	0	1	3.86E-06	3.57E-06	2.86E-07	2.86E-07
US01e4	0	1	3.86E-06	3.57E-06	2.86E-07	2.86E-07
US01f4	0	1	3.86E-06	3.57E-06	2.86E-07	2.86E-07
US01c2	0	1	4.28E-06	3.14E-06	1.14E-06	1.14E-06
US01d4	0	1	3.71E-06	3.71E-06	0.00E+00	0.00E+00
US01d5	0	1	4.28E-06	3.14E-06	1.14E-06	1.14E-06

Factorial Design Result (US-01)

- High Sensitivity
 - Inability to rotate and lift-off after no rejection of take-off (c2)
 - Maintaining control after take-off (d5)
- Low Sensitivity
 - Rejected take-off at high speed (c1)
 - Maintaining control with no rejection and no lift-off (d4)

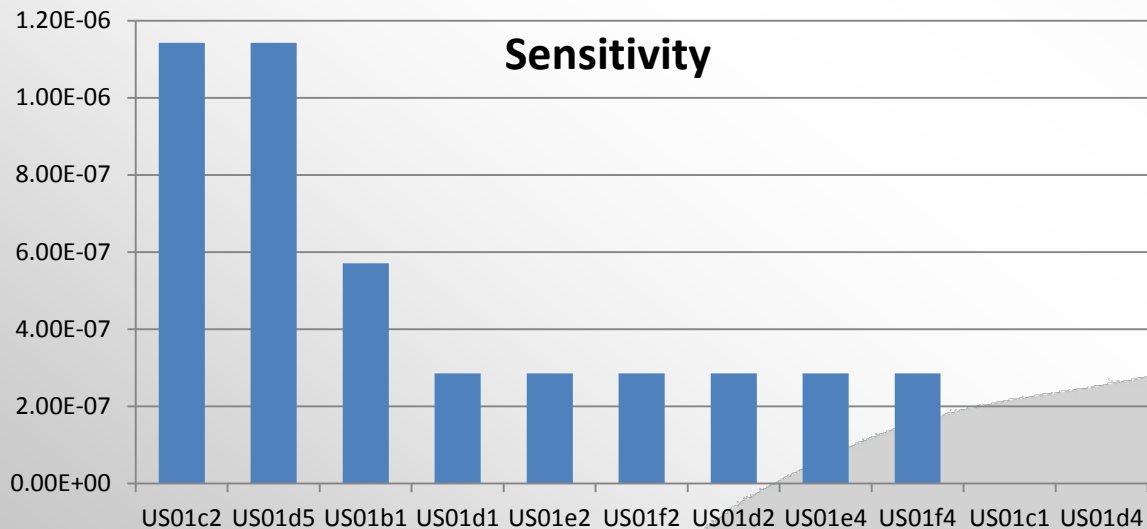

Factorial Design Result (US-01)

- Assume different high and low probabilities (Case 2)

Unique ID	US01b1	US01c1	US01d1	US01e2	US01f2	US01d2	US01e4	US01f4	US01c2	US01d4	US01d5
Low Prob.	0.3	0	0.7	0	0	0	0	0	0	0	0
High Prob.	1	0.3	1	0.05	0.05	0.1	0.05	0.05	0.1	0.05	0.1

- Different results in terms of values and ranks.

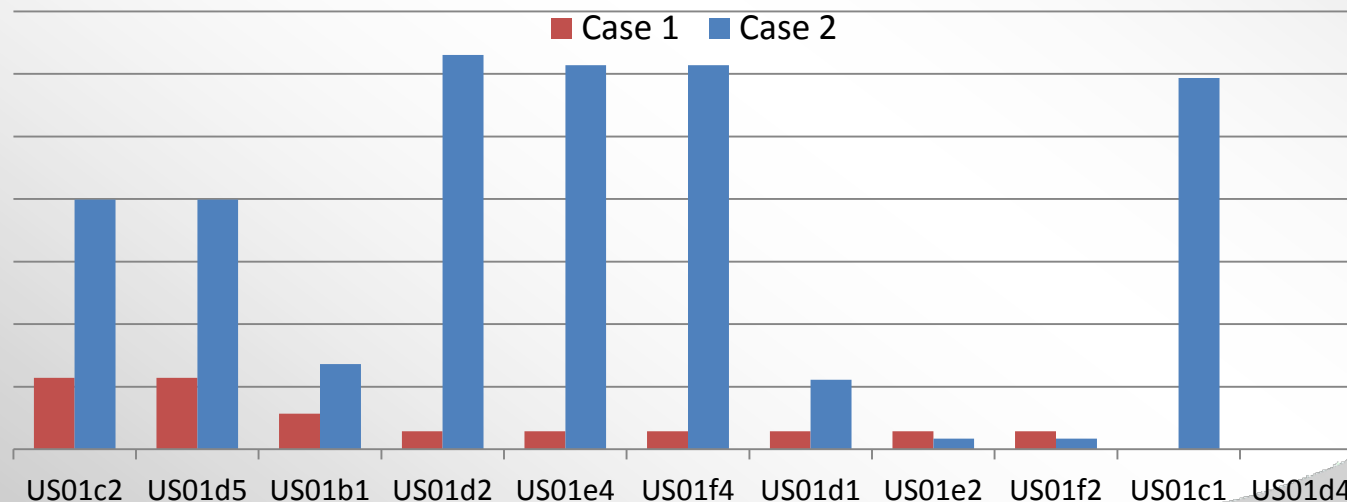

- Highly depend on how the range of probability for pivotal events are assumed.

Sensitivity Result by Structures

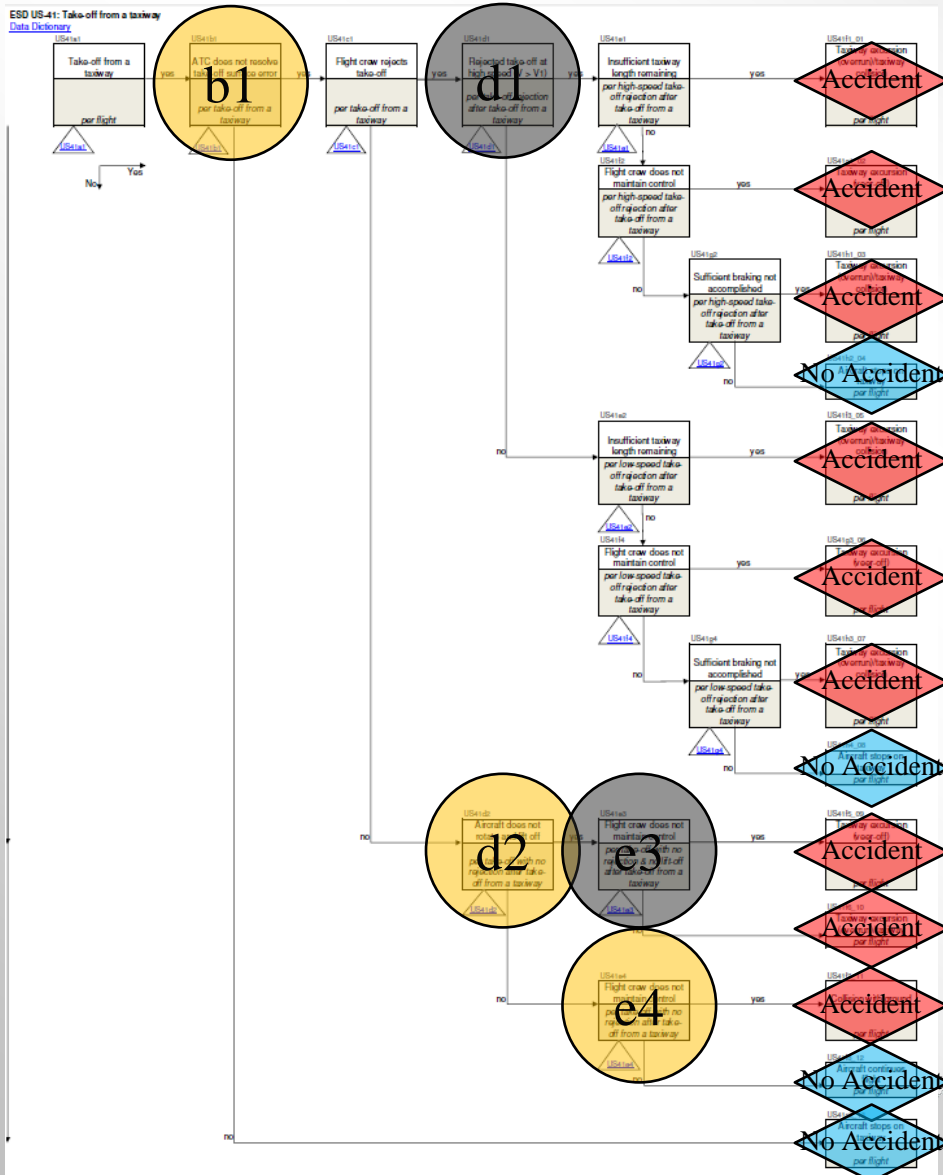

- US-39, US-41
- Another structure for take-off phase ESDs
- More Significant: ATC not resolve the initiating event (b1), capability of rotating and lifting off with no take-off rejection (d2) and maintaining control after lifting off (e4)
- Less Significant: High speed take-off rejection (d1) and maintaining the aircraft under control after failure of lifting off (e3)

Sensitivity Result by Structures

- US-12 (F), 26, 27 (A&L)

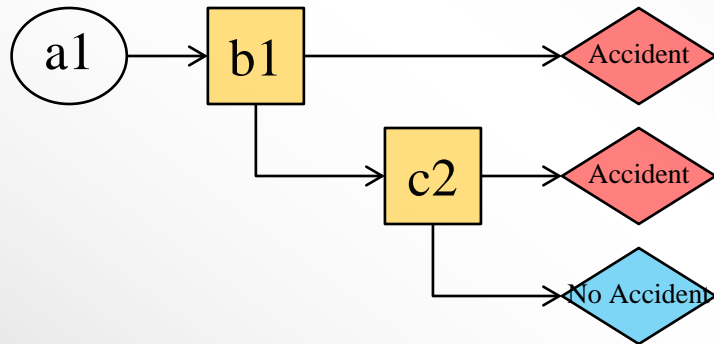

- US-31, 32, 35, 36 (F, T, A&L)

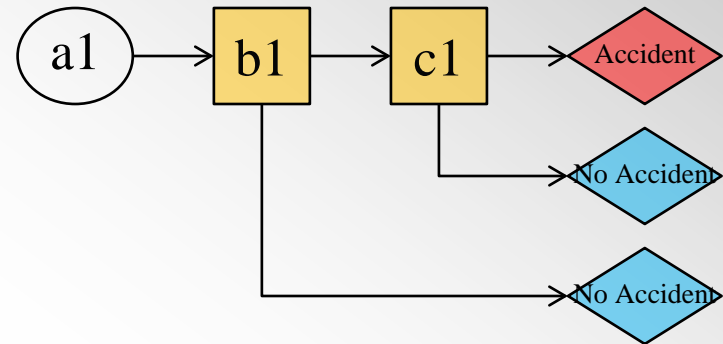

- US-18 (F)

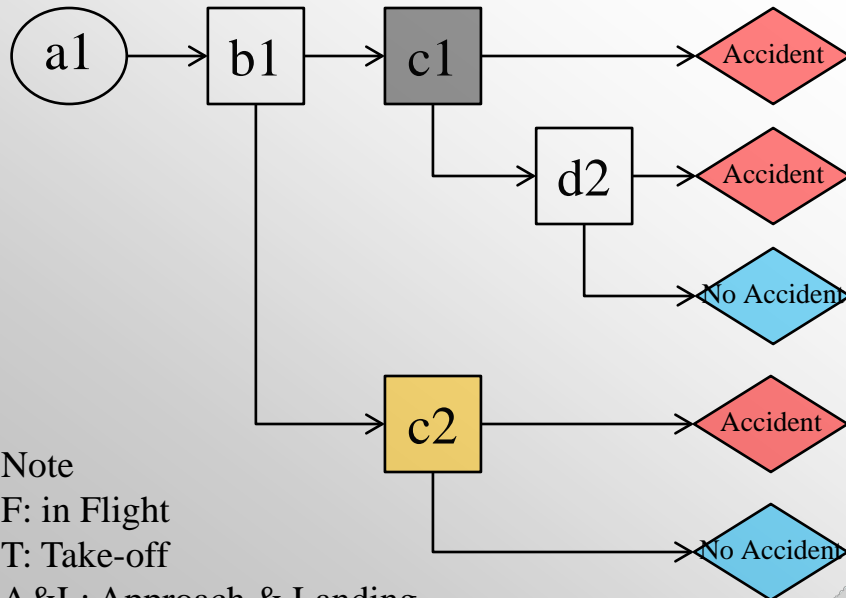

- US-42, 43 (A&L)

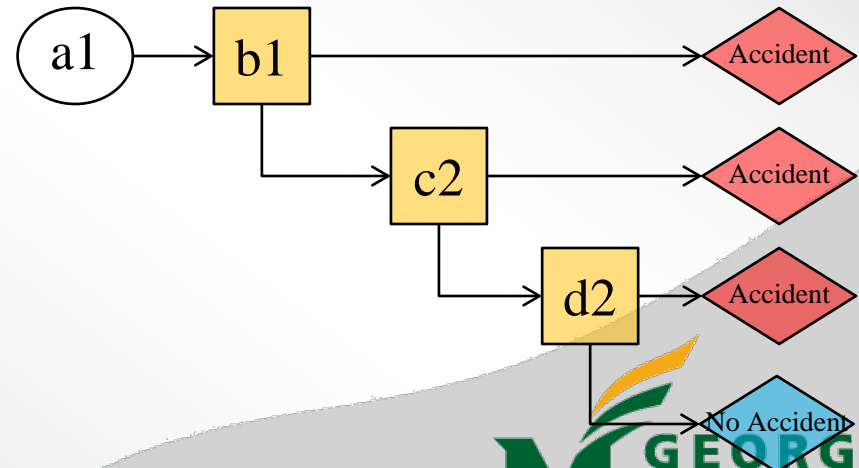

Note
F: in Flight
T: Take-off
A&L: Approach & Landing

Consequence Data

- Use fatality probabilities to distinguish types of accidents

Accident Type	Accident Fatality Probability (ESD #)	Avg. Prob.
Aircraft continues flight damaged	0.00 (11, 33)	0.00
Aircraft lands off runway	0.0297 (18)	0.0297
Collision in mid-air	0.2041 (31)	0.2041
Collision on runway	0.6316 (32)	0.6316
Collision on taxiway or apron	9.09E-05 (36)	9.09E-05
Collision with ground	0.00 (01, 02, 03, 04, 08, 09, 21, 23, 25, 33, 39, 40, 41), 0.1429 (05), 0.4545 (06), 0.9259 (10), 0.9912 (13), 0.7143 (14), 0.6296 (15), 0.8571 (17), 0.2214 (18), 0.5238 (18), 0.1013 (19), 0.3571 (19), 0.4483 (38), 1.00 (11, 12, 16, 37)	0.6480
Controlled flight into terrain or obstacle	0.7938 (35), 1.00 (12)	-
In-flight break-up	0.00 (33), 1.00 (17)	1.00
Runway excursion (overrun)	0.00 (01, 02, 03, 04, 05, 09, 10, 19, 21, 23, 25, 27, 39, 40, 43), 0.50 (04), 0.0279 (19), 0.0710 (26), 0.98 (39)	0.3812
Runway excursion (veer-off)	0.00 (01, 02, 03, 04, 05, 09, 10, 19, 21, 23, 25, 26, 27, 39, 40, 43)	0.00
Taxiway excursion (overrun)/taxiway collision	0.00 (41, 42)	0.00
Taxiway excursion (veer-off)	0.00 (41, 42)	0.00
Undershoot / Overshoot	0.00 (21, 23, 25, 40), 0.5217 (19)	0.5217

Sensitivity Result, w/ Accidents

ESD US-01: Aircraft system failure during take-off
Data Dictionary

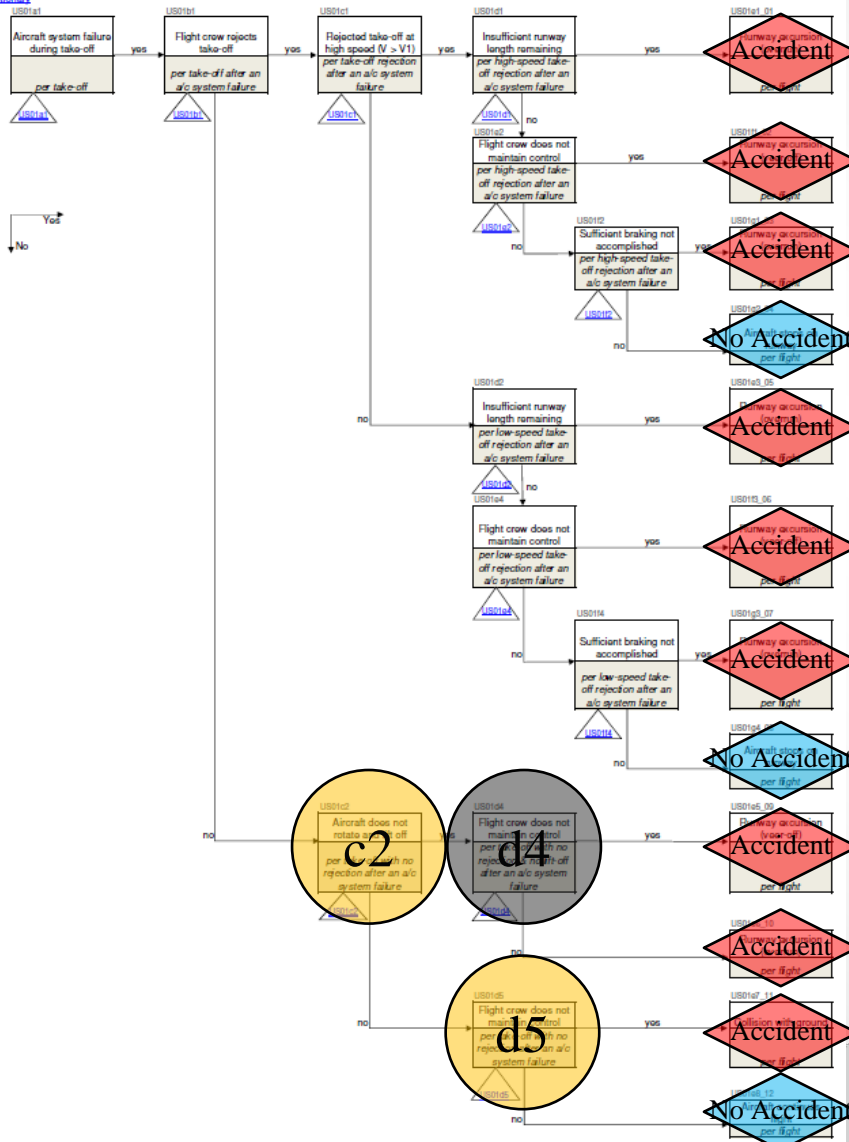

- US-01, US-02, US-03, US-04, US-05, US-09, US-10
- One of a few structures for take-off phase ESDs
- Significant: Capability of rotating and lifting off after no take-off rejection (c2) and maintaining control after lifting off (d5)
- Less Significant: Maintaining control after failure of lifting off (d4)

Sensitivity Result, w/ Accidents

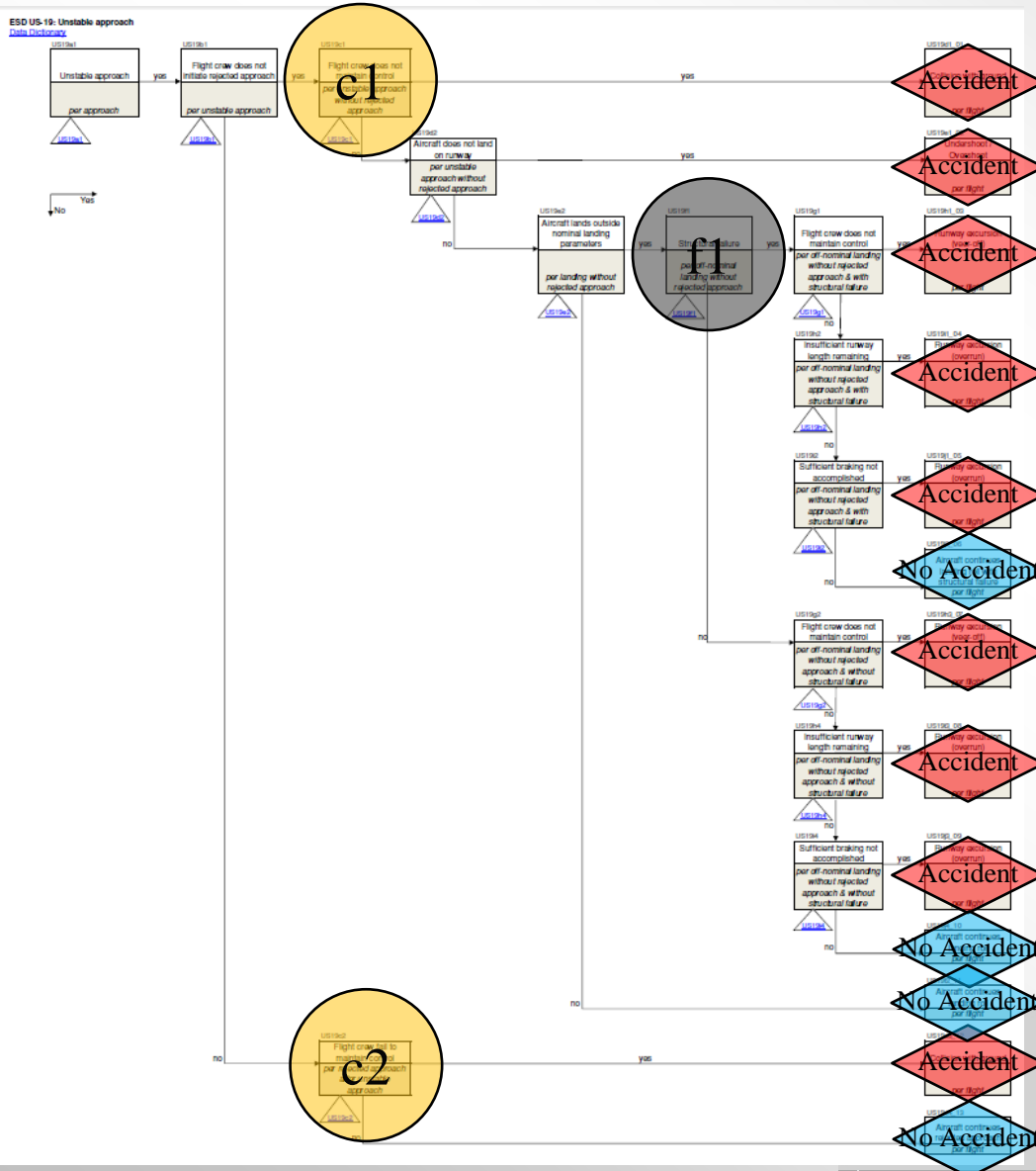

- US-19, US-21, US-23, US-25, US-40
- Structure for approach & landing phase ESDs
- Significant: Failure to maintain control without rejected approach (c1) and after rejected approach (c2)
- Less Significant: Structural failure after off-nominal landing (f1)

Sensitivity Result w/ Fatality Data

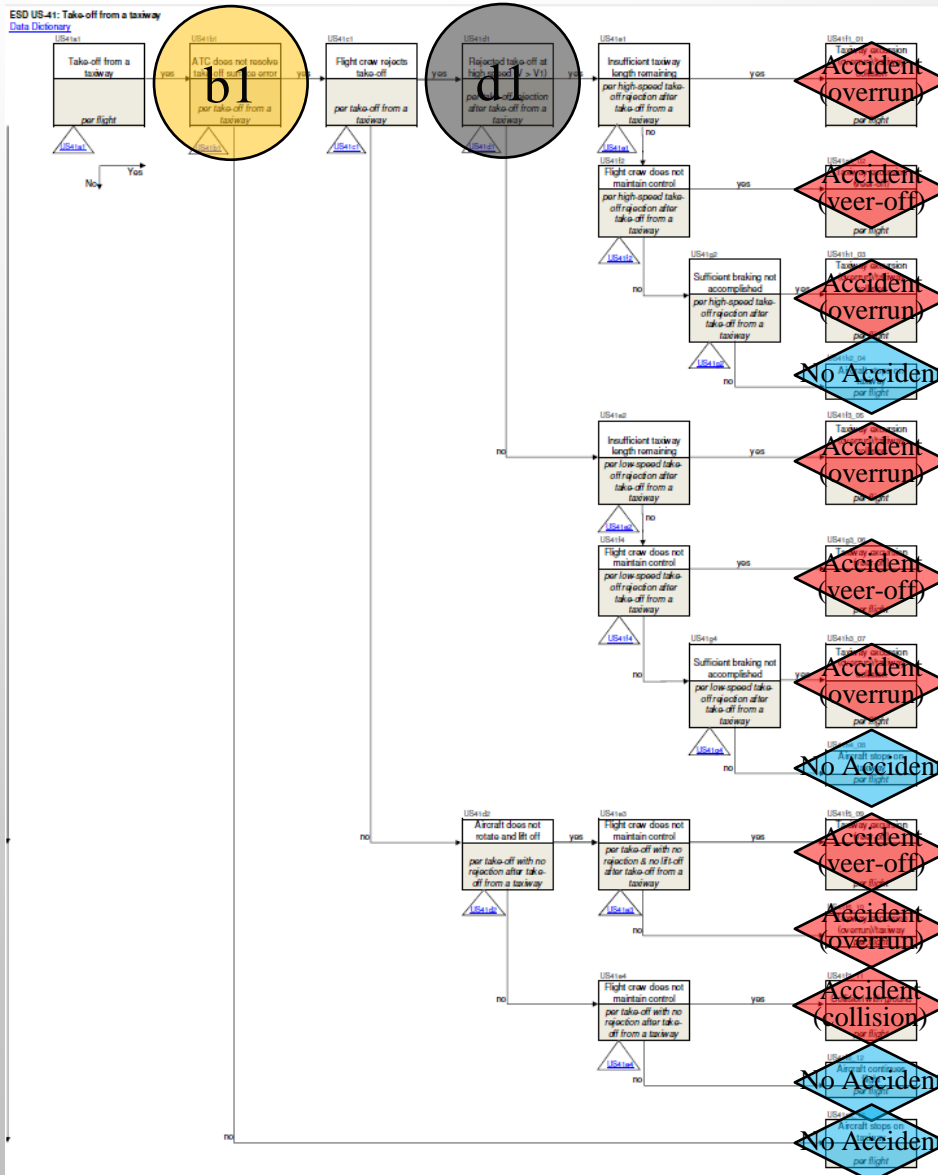

- US-39, US-41
- Another structure for take-off phase ESDs
- Significant: ATC not resolve the initiating event (b1) from factorial design analysis
- Less Significant: Rejected take-off at high speed (d1) from factorial design

Sensitivity Result, w/ Accidents

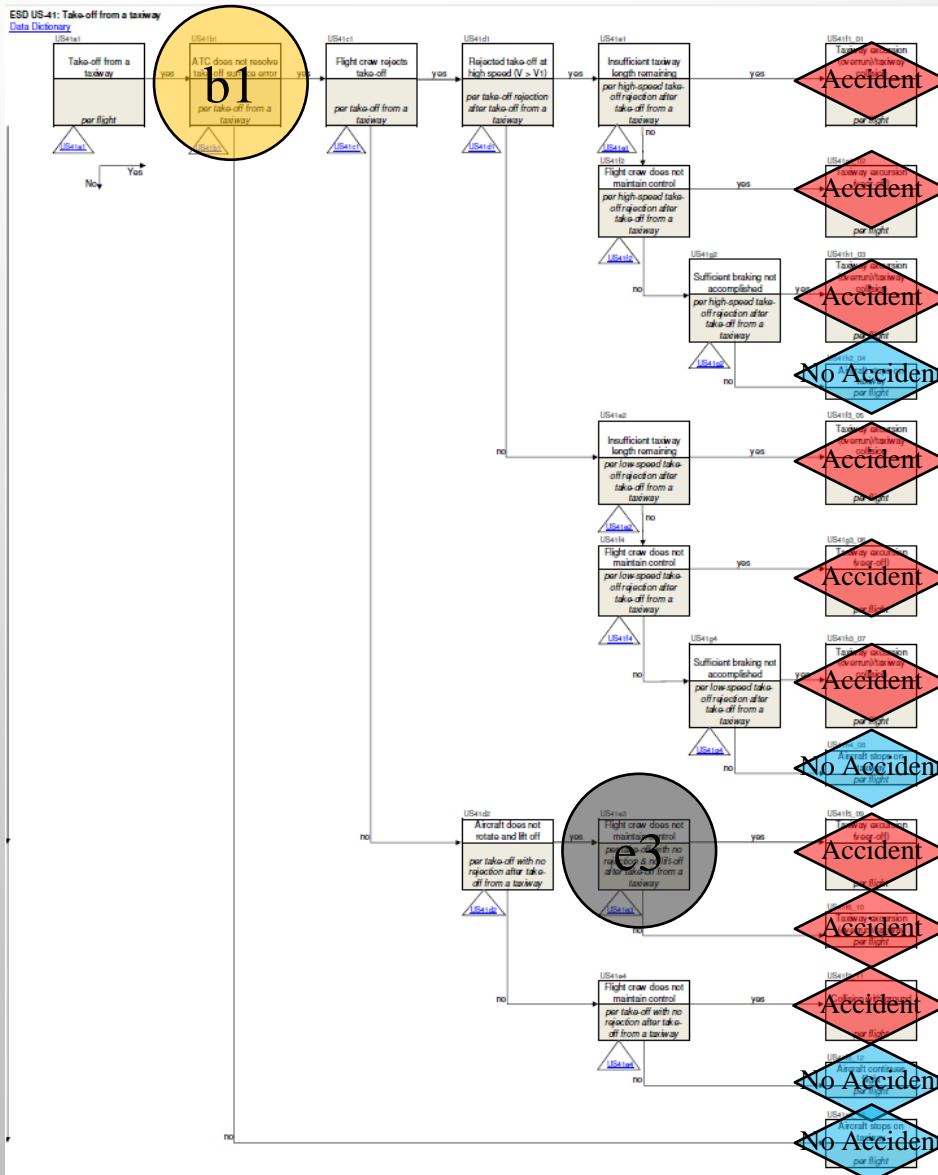

- US-39, US-41
- Another structure for take-off phase ESDs
- Significant: ATC not resolve the initiating event (b1) from factorial design analysis
- Less Significant: Maintaining the aircraft under control after failure of lifting off (e3)

Common Pivotal Events

- 205 pivotal events in all 35 ESDs
 - 27 unique labels for these events.
- Some labels appear in multiple ESDs, possibly multiple times in the same ESD
 - 13 labels appear only once

Pivotal Events	# of observations
Flight crew does not maintain control	75
Sufficient braking not accomplished	32
Insufficient runway length remaining	27
Aircraft does not rotate and lift off	9
Flight crew rejects take-off	9
Rejected take-off at high speed ($V > V1$)	9
Aircraft does not land on runway	5
Aircraft lands outside nominal landing parameters	5
Structural failure	5
ATC does not resolve the conflict	4
Flight crew does not initiate rejected approach	4
Insufficient taxiway length remaining	3
...	...

Common Fault Tree Events

- 3,454 fault tree events in all 240 fault trees
 - 226 unique labels for these events.
- More than half of labels appear in multiple trees, some labels seen more than 100 times.
 - 93 events seen only once

Fault Tree Events	# of observations
No warning system in place-FC	200
Warning system fails to give warning-FC	200
Warning system gives erroneous warning-FC	200
Inadequate FC procedures	197
Ineffective flight crew CRM	197
FC technical equipment failure	196
Other system provides incorrect information-FC	181
Poor manual flight control	156
Poor automated systems management	155
Aircraft state inhibiting ability to maintain control	77
Environmental factors inhibiting ability to maintain control	76
Maintenance conducted incorrectly	56
...	...

Methodology

- Assume same-label events are the same
- Sensitivity methodology:
 - Maintain unique baseline probability values of events
 - Multiply same-label events by a common factor (e.g., increase all nodes labeled “rejected takeoff at high speed” by 1%)
 - Calculate the new overall accident frequency through all ESDs and compare to the baseline accident frequency.
 - Assumes that a change would result in a similar proportional increase in values, even if the baseline probabilities are different

Are Same-Label Events the Same?

- Same-label events in different places can have different probabilities
- Hard to tell when to treat as different or the same
 - “Flight crew does not maintain control” can be on the ground (rejected take-off) or in air (after take-off)

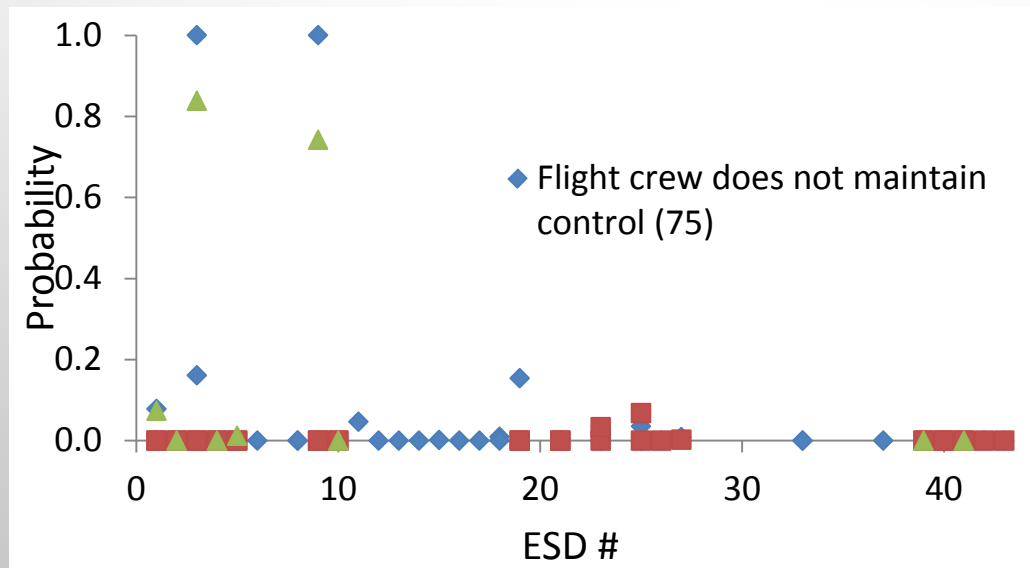

Example

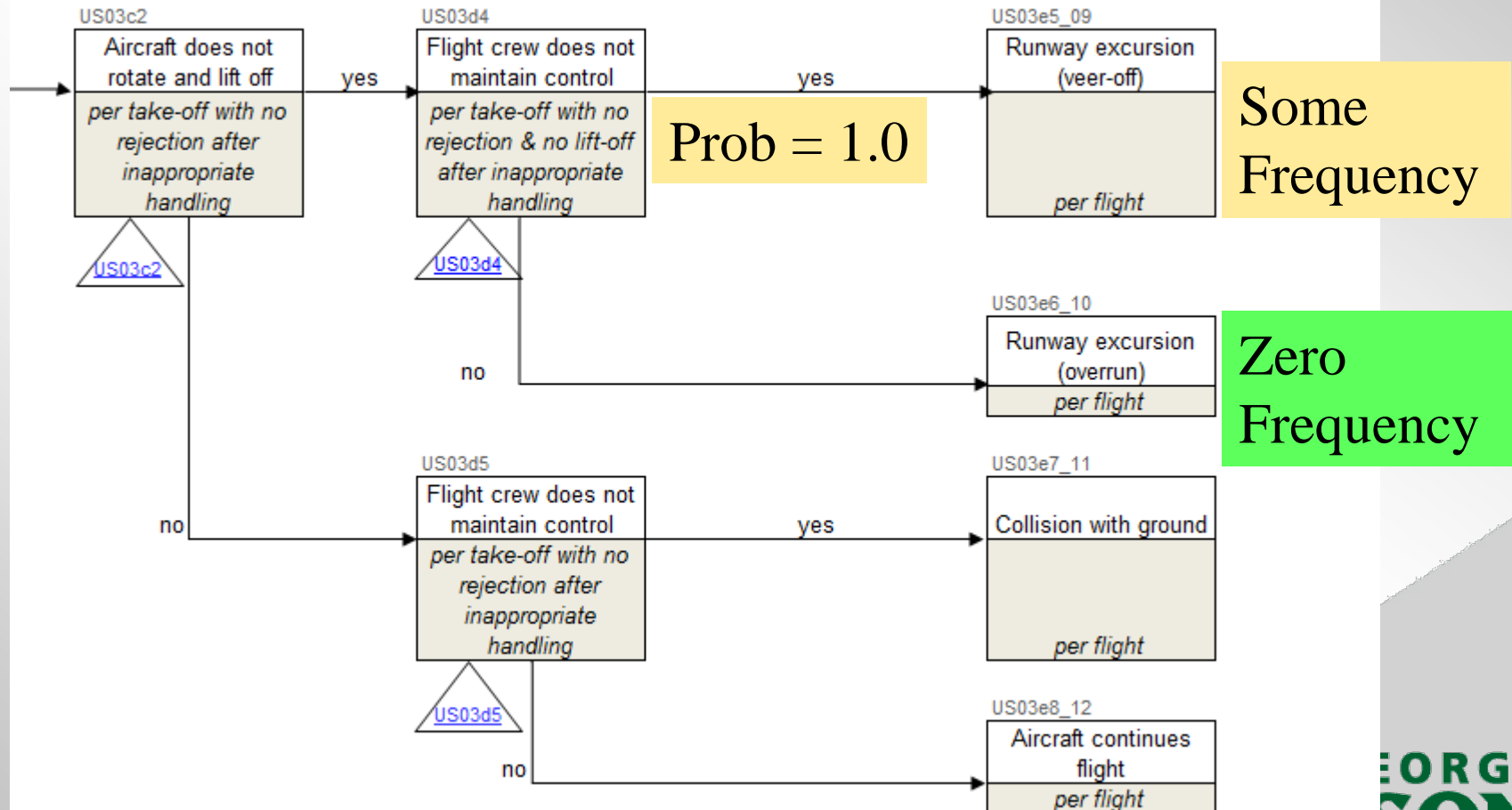

Initiating Event Probabilities

Initiating events per operation

Absolute scale

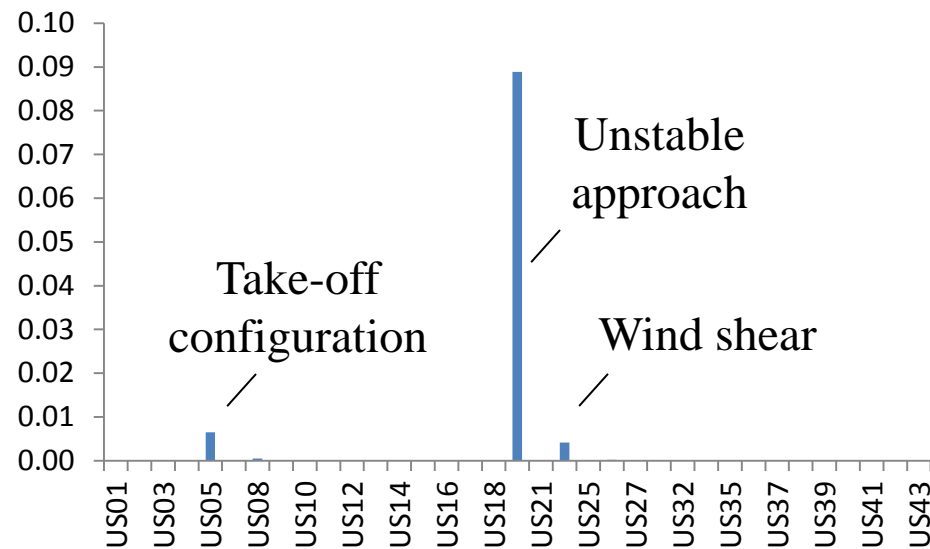

Log scale

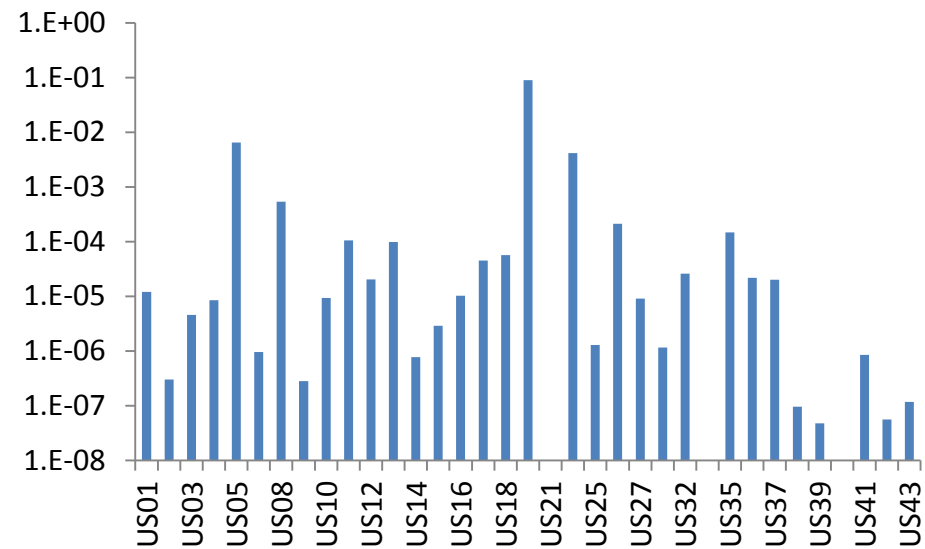

Conditional Fatality Probabilities

Expected fatalities per initiating event

Absolute scale

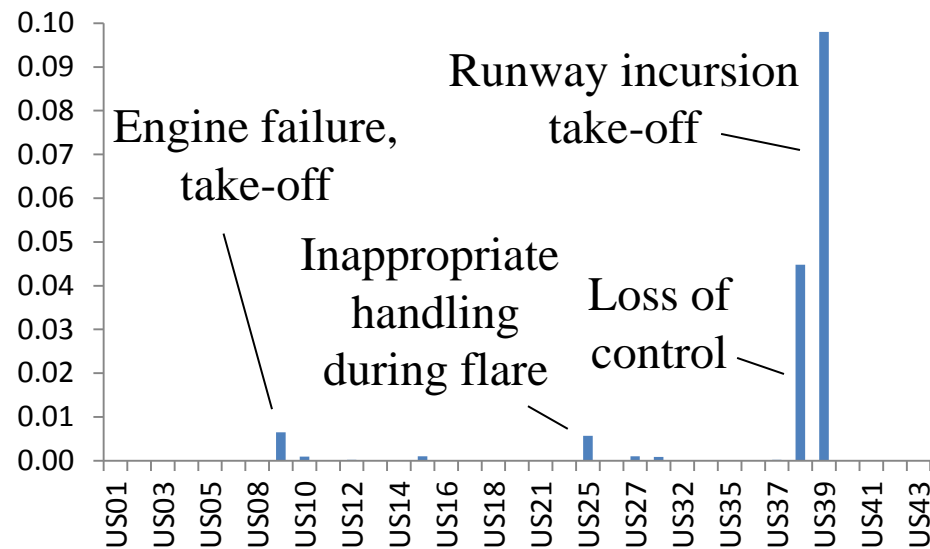

Log scale

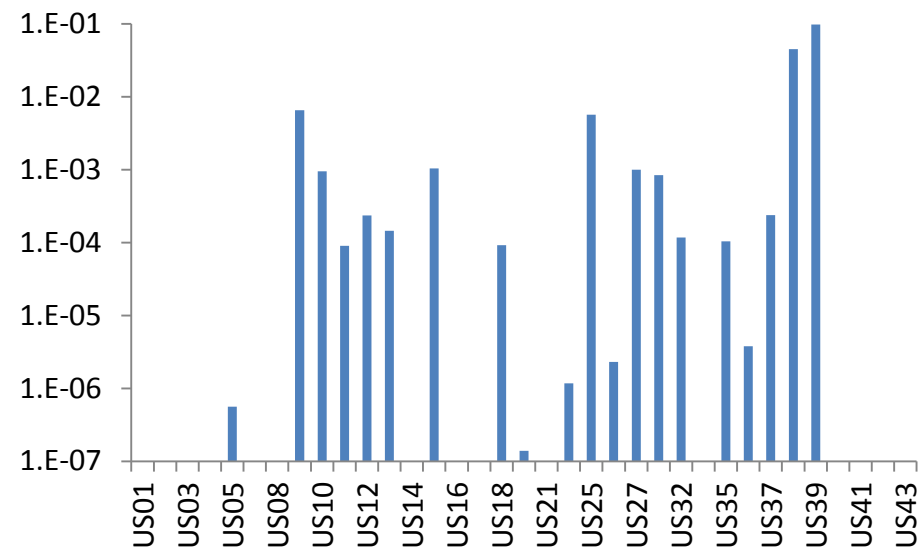

Methodology

- For each event (defined by a unique label):
 - Increase the probabilities of each event by 1% from baseline probabilities in all ESDs/fault trees where the event is observed.
 - Calculate the new overall accident frequency through all ESDs and compare to the baseline accident frequency.

$$Sensitivity = \sum_{i=1}^{\# \text{ of ESDs}} \frac{((New \text{ Acc Freq})_i - (Base \text{ Acc Freq})_i)}{(Base \text{ Acc Freq})_i}$$

Example Calculation

- Example event: ATC does not resolve the conflict
- Sensitivity (C) = (B - A) / A

ESD	Initiating Event	Initiating Event Freq.	Baseline Accident Prob.	Baseline Accident Freq.	New Accident Prob.	New Accident Freq.	Sensitivity
US01	Aircraft system failure during take-off	1.20E-05	4.25E-04	5.10E-09	4.25E-04	5.10E-09	
...	
US31	Aircraft are positioned on collision course in flight	1.16E-06	4.12E-03	4.80E-09	4.16E-03	4.85E-09	
US32	Runway incursion involving a conflict	2.58E-05	1.86E-04	4.79E-09	1.87E-04	4.84E-09	
US33	Cracks in aircraft pressure boundary	0.00		0.00		0.00	
US35	Conflict with terrain or obstacle imminent	1.47E-04	1.31E-04	1.92E-08	1.32E-04	1.94E-08	
US36	Conflict on taxiway or apron	2.18E-05	4.18E-02	9.11E-07	4.22E-02	9.20E-07	
...	
US43	Landing on the wrong runway	1.17E-07	0.00E+00	0.00E+00	0.00E+00	0.00E+00	
Total		1.01E-01	3.22E-01	1.510E-06	3.22E-01	1.519E-06	0.622%

A

B

C

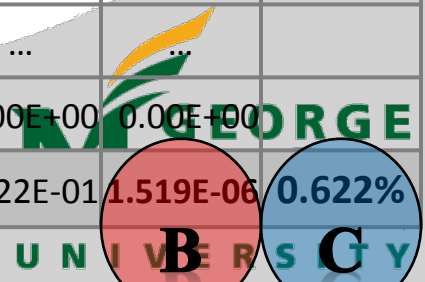

Top 10 Pivoting Events (Accidents)

- ‘ATC does not resolve the conflict’ is most significant event
 - Increases accident frequency by 0.622% when the event probability increases by 1%.
- Most of significant pivotal events observed multiple times in ESDs

Metric = accident frequency

Pivotal Events	% change of accident frequency	# of observations
ATC does not resolve the conflict	0.622%	4
Flight crew or vehicle driver does not resolve the conflict	0.606%	2
Flight crew does not maintain control	0.187%	75
Flight crew does not detect and extinguish fire	0.076%	1
Flight crew does not initiate rejected approach	-0.069%	4
Rejected take-off at high speed ($V > V1$)	-0.065%	9
Sufficient braking not accomplished	0.054%	32
Aircraft lands outside nominal landing parameters	0.054%	5
Insufficient runway length remaining	0.035%	27
Flight crew rejects take-off	0.020%	9

Top 10 Fault Tree Events (Accidents)

- ‘Avoidance essential’ is most significant fault tree event
 - Increases accident frequency by 0.622% when the probabilities of the event increase by 1%.
- Most of significant fault tree events observed a relatively small number of times in ESDs.

Metric = accident frequency

Fault Tree Events	% change of accident frequency	# of observations
Avoidance essential	0.622%	4
Conflict in non-movement area	0.412%	1
Avoidance action creates new conflict	0.211%	4
Communications technical equipment failure	0.112%	33
Incorrect FC/driver response to controller action	0.111%	2
Other aircraft deviation	0.111%	4
Situation exceeds capability to correct	0.107%	11
FC/driver fails to take correct avoidance action	0.106%	2
FC/driver misjudges avoidance action	0.106%	2
Flight crew fails to take correct avoidance action	0.106%	2

Top 10 Fault Tree Events (Fatality)

- ‘Situation exceeds capability to correct’ is most significant fault tree event
 - Increases fatality frequency by 0.262% when the probabilities of the event increase by 1%.
- Mostly different top 10 list (red = in both lists)

Metric = fatality frequency, red = in both lists

Fault Tree Events	% change of fatality frequency	# of observations
Situation exceeds capability to correct	0.262%	11
Avoidance essential	0.163%	4
Unsuccessful visual avoidance	0.148%	5
Ineffective flight crew CRM	0.121%	197
Inadequate FC procedures	0.114%	197
FC technical equipment failure	0.113%	196
Aircraft state inhibiting ability to maintain control	0.101%	77
Poor manual flight control	0.088%	156
Environmental factors inhibiting ability to maintain control	0.088%	76
Braking system not applied correctly	0.086%	32

Conclusions

- Investigated impact of changes in event probabilities on system-wide metrics (accident probability, fatality probability)
- Events may be evaluated as important for a variety of reasons
 - Significant effect within an important ESD
 - Appearing multiple times throughout ISAM
- Relationship between # of observations and sensitivity are not clearly detected
- Many of important pivotal events in previous analysis are also significant in common event analysis
 - ‘ATC does not resolve the conflict’, ‘Flight crew does not maintain control’, ‘Sufficient braking not accomplished’, ‘Insufficient runway length remaining’, etc.
- To a lesser extent, similar observation for fault tree events
 - ‘Communications technical equipment failure’, ‘Other aircraft deviation’, ‘Situation exceeds capability to correct’
- For pivotal events, top 10 list is similar using accident and fatality metrics, different for fault-tree events

Death Rates in U.S.

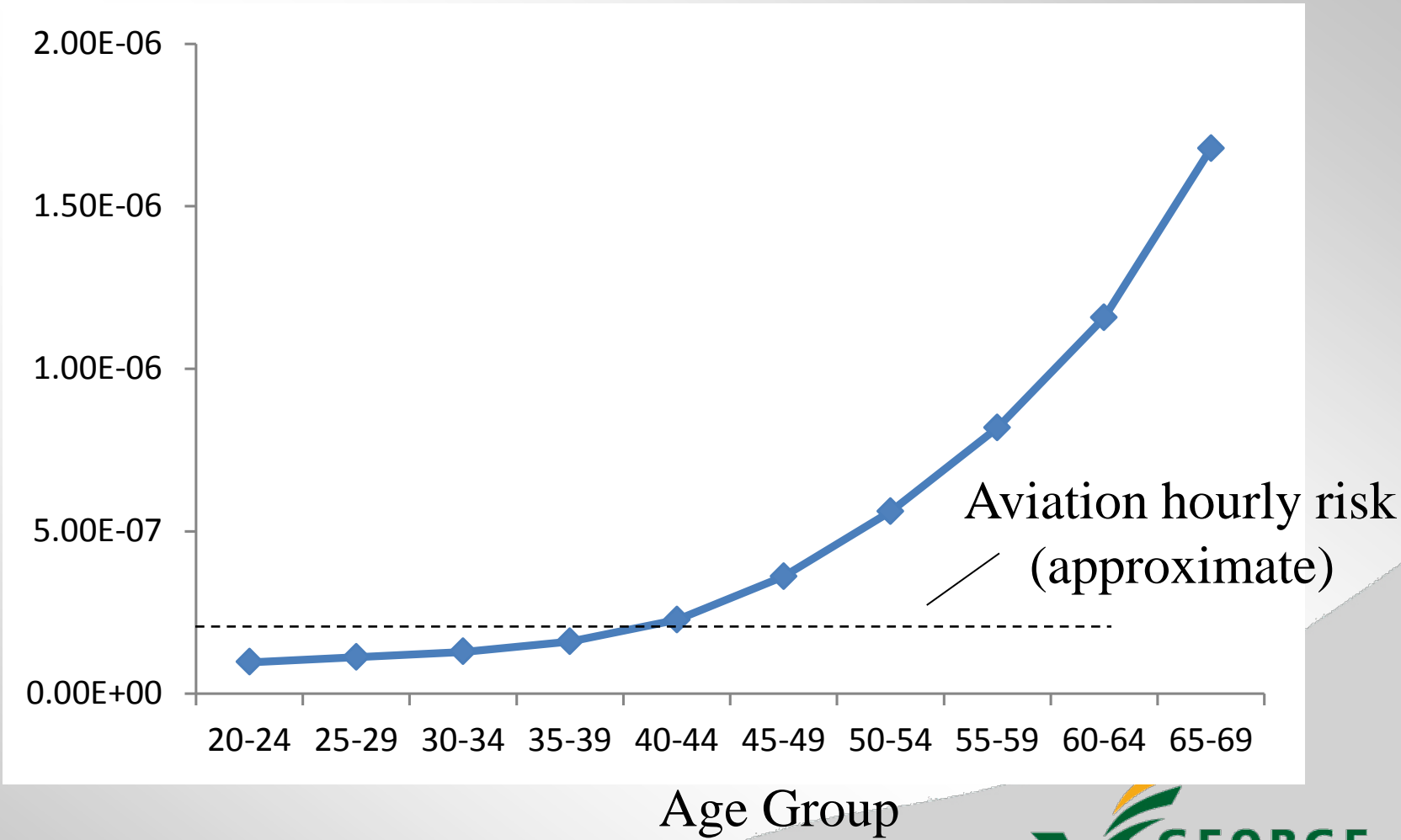

Event-Sequence Diagram List

US 01	Aircraft system failure during take-off
US 02	ATC event during take-off
US 03	Aircraft directional control by flight crew inappropriate during take-off
US 04	Aircraft directional control related system failure during take-off
US 05	Incorrect configuration during take-off
US 06	Aircraft takes off with contaminated flight surface
US 08	Aircraft encounters wind shear after rotation
US 09	Single engine failure during take off
US 10	Pitch control problem during take-off
US 11	Fire onboard aircraft
US 12	Flight crew member spatially disoriented
US 13	Flight control system failure
US 14	Flight crew member incapacitation
US 15	Ice accretion on aircraft in flight
US 16	Airspeed, altitude or attitude display failure
US 17	Aircraft encounters adverse weather
US 18	Single engine failure in flight
US 19	Unstable approach
US 21	Aircraft weight and balance outside limits during approach
US 23	Aircraft encounters wind shear during approach or landing
US 25	Aircraft handling by flight crew inappropriate during flare
US 26	Aircraft handling by flight crew inappropriate during landing roll
US 27	Aircraft directional control related systems failure during landing roll
US 31	Aircraft are positioned on collision course in flight
US 32	Runway incursion involving a conflict
US 33	Cracks in aircraft pressure boundary
US 35	Conflict with terrain or obstacle imminent
US 36	Conflict on taxiway or apron
US 37	Wake vortex encounter
US 38	Loss of control due to poor airmanship
US 39	Runway incursion involving incorrect presence of single aircraft for takeoff
US 40	ATC event during landing
US 41	Taking off from a taxiway
US 42	Landing on a taxiway
US 43	Landing on the wrong runway